



5G-ACIA White Paper

Using Digital Twins to Integrate 5G into Production Networks

5G Alliance for Connected Industries and Automation

Table of Contents

1	Executive Summary	3
2	Introduction	4
3	Reference Architecture Model: Industry 4.0 (RAMI)	4
	3.1 Asset Administration Shells (AASs) as enablers of digital twins in the factory of the future	5
	3.2 Evolution of an AAS into an active AAS	10
4	5G Network and System	13
	4.1 Functional domains and planes of the 5G system	14
	4.2 5G system architecture with a core network in a service-based representation	14
	4.3 Mobility and roaming between different 3GPP network operators	16
	4.4 Network slicing	16
	4.5 Non-Public Networks	17
	4.6 Alignment considerations at the architectural level	20
5	5G Asset Administration Shell	20
	5.1 Requirements for a 5G Asset Administration Shell definition	20
	5.2 Considerations for developing a 5G Asset Administration Shell	21
	5.2.1 5G AAS from a functional perspective of 5G as a communication system	21
	5.2.2 5G AAS from the physical perspective: what is 5G equipment and where is it located?	22
	5.2.3 5G AAS from the virtual perspective: shared computing environments	22
	5.2.4 Contractual aspects of defining the 5G AAS	22
	5.2.5 Lifecycle aspect	23
	5.3 Definition of 5G UE AAS	24
	5.4 Definition of a 5G network AAS	26
	5.5 Logical Interfaces to the 5G network AAS/5G UE AAS	28
	5.6 Changes to 5G infrastructure	30
	5.7 TSN Integration with 5G networks	31
	5.8 Properties that must be covered by 5G AAS submodels	31
	5.8.1 5G Network AAS	32
	5.8.2 5G UE AAS	33
6	Beneficial AAS Use Cases	34
	6.1 Use case 1: QoS orchestration in a 5G network	34
	6.2 Use case 2: firmware updates	34
	6.3 Use case 3: intrusion detection system (IDS)	34
	6.4 Use case 4: flexible communication across hierarchies enabled by 5G	38
	6.5 Use case 5: service-specific deployment of UPFs	38
7	Conclusions	39
8	Key Terms and Definitions	39
9	Acronyms	41
10	References	42
11	5G-ACIA Members	46

1 Executive Summary

This white paper provides an overview of how industrial 5G supports the implementation of Industry 4.0 concepts. One important aspect is integrating 5G into Industry 4.0 by defining 5G Asset Administration Shell (AAS).

The concept of Asset Administration Shells is becoming a key building block for the factory of the future. These are about to be standardized within the scope of the International Electrotechnical Commission (IEC), and a new organization called "Industrial Digital Twin Association" is being established by ZVEI and VDMA to drive the implementation of AAS and its commercial success.

Integrating a 5G system into the factory of the future requires a suitable description of the 5G system based on AAS principles. In this paper, various aspects are discussed and a model proposed for a structured description of the overall 5G network, including 5G UE (user equipment).

This paper also formulates tentative definitions of submodels and parameters/properties based on the currently valid 5G definitions of 3GPP.

Outlook:

The dialog initiated with the expert groups of the "Plattform Industrie 4.0" should be continued for working out the details of an AAS model for a 5G system.

A new extension of the AAS, called "active AAS", is also currently under discussion in connection with Industry 4.0 standardization activities. The active AAS is designed to support and enable self-optimization of the overall factory network while, for example, processing dynamic QoS negotiations. It also includes wireless links and may require greater interaction between the factory and 5G networks. One of the goals of Industry 4.0 is to unify the control and management of production systems, and a 5G system may become an integral part of this while being managed and controlled by factory network management systems.

About 5G-ACIA

The 5G Alliance for Connected Industries and Automation (5G-ACIA) was established to serve as the central and global forum for addressing, discussing, and evaluating relevant technical, regulatory, and business aspects of 5G for the industrial domain. It reflects the entire ecosystem and all relevant stakeholder groups, including the operational technology (OT) industry (industrial automation companies, engineering companies, production system manufacturers, end users, etc.), the ICT industry (chip manufacturers, network infrastructure vendors, mobile network operators, etc.), academia, research institutes, and other relevant players. The primary objective of 5G-ACIA is to maximize the applicability of 5G technology and 5G networks to the industrial domain. 5G-ACIA's mission is to make sure that the interests and needs of the industrial domain are adequately considered in connection with 5G standardization and regulation and that ongoing 5G developments are understood by and effectively transferred to the industrial domain.

2 Introduction

This paper describes the integration of a 3GPP 5G system in accordance with the underlying ideas of Industry 4.0 (I4.0), which are mainly defined by the “Plattform Industrie 4.0”, a German initiative to promote the evolution of Industry 4.0” [23].

First the Reference Architecture Model Industry 4.0 (RAMI 4.0) is described in Chapter 3, then the concept of an Asset Administration Shell (AAS) is addressed. An AAS is the industrial implementation of a digital twin (DT) for Industry 4.0, and the two terms are used synonymously here.

Chapter 4 provides a compact overview of the functions of the 5G system and possible interfaces to a factory network and for control and management. Chapter 5 then proposes

the use of a pair of digital twins (AASs) of the 5G system to facilitate integration of 5G into a factory management and control system: a 5G network AAS plus a second AAS for 5G user equipment (UE). Both of these are described in detail, and properties are proposed for defining “submodels”, which play an important role in structuring AASs, and describing dedicated applications in different domains.

Chapter 6 presents and explains examples of AAS-specific use cases to illustrate the proposed AAS submodels.

The paper concludes by describing a possible implementation and the required interfaces between factory management and the 5G system.

3 Reference Architecture Model: Industry 4.0 (RAMI)

A significant outcome of the “Plattform Industrie 4.0” is the Reference Architecture Model Industry 4.0 (RAMI 4.0): a three-dimensional, layered model that explores the connections among IT, manufacturing, and product lifecycles in order to clearly structure areas whose inclusion is required (see Figure 1). It provides an orientation for situating work such as this paper within the workspace embraced by Industry 4.0. [9]

Vertical and horizontal interconnections among multiple systems, across corporate boundaries and throughout lifecycles are characteristic features of Industry 4.0 and defining attributes of production in the future.

The “hierarchical levels” axis covers the essential functionalities of a factory or entire plant, similarly to the classical automation pyramid. It is based on the IEC 62264 [11] and IEC 61512 standards while adding the elements of “product” and “connected world”.

“Lifecycle value stream” is the second dimension in the model. It borrows from IEC 62890 and reflects the lifecycles of products, machines, and supporting types as well as the lifetimes of product instances.

The third dimension (“layers”) describes the system’s IT-based elements in a structured manner. It starts with the asset level and extends upward to the business perspective.

A defining principle of Industry 4.0 is transparency of all relevant information, enabled by application-oriented interconnectivity of all instances, both within and beyond the factory. It addresses all aspects of the value chains. The communication layer defined in the RAMI 4.0 reference model ensures reliable, timely, flexible, and secure exchange of data among all points of the manufacturing process. Communication systems—comprising communication technologies, networks and protocols—are essential components of an Industry 4.0 system.

Communication is broken down into the underlying physics, data transmission, and basic services. The content of the communication layer corresponds to the well-known OSI model (ISO 7498).

Similarly, the NAMUR Open Architecture (NOA) [22] concept developed by the process industries takes a simplified view that also opens up possibilities for enabling innovative solutions for new and existing factories. The (critical) process control core is a largely enclosed, autonomous system. The main difference is an open interface between the existing core process control domain and the monitoring and optimization domain. It broadly also follows the principles of I4.0.

3.1 Asset Administration Shells (AASs) as enablers of digital twins in the factory of the future

In accordance with [15], assets in Industry 4.0 can belong to the following categories:

- Physical assets, e. g. equipment, raw materials, supplies, and products
- Software, e. g. firmware, engineering tools, and applications
- Documents (media and documentation)
- Intangible assets, e. g. software licenses, standards, and information
- Human resources, e. g. service technicians, programmers, and operators
- Services

Fig. 1: RAMI 4.0 model

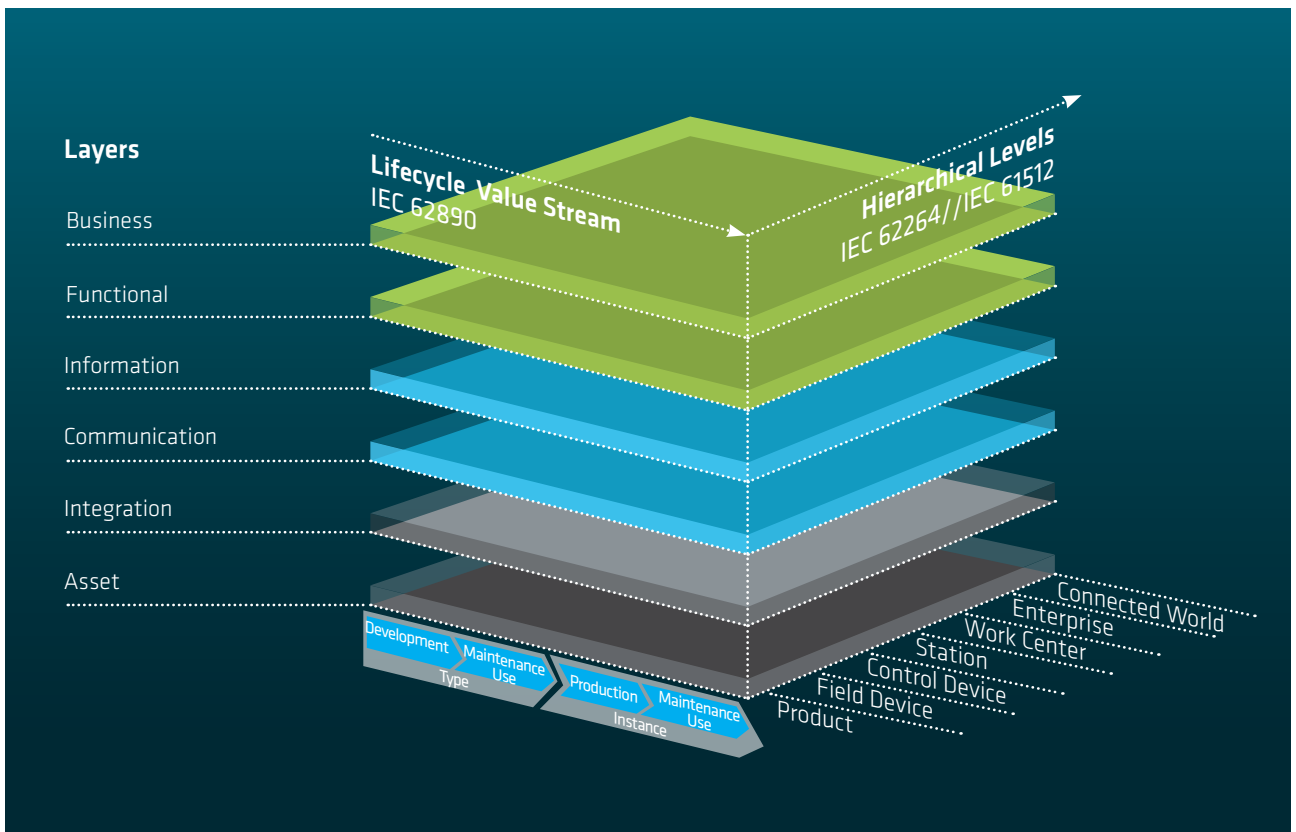

Source: Plattform Industrie 4.0 and ZVEI

Together with the corresponding *Asset Administration Shells* (AASs), these assets may be regarded as Industry 4.0 (I4.0) components (Figure 2). AASs are key components of a smart factory and RAMI 4.0. They provide all data and functions related to an asset and constitute a universal information framework.

All assets of I4.0-compliant factories are modeled, regardless of whether these are physical, virtual (software), intangible, or contractual, and each has its own AAS [15]. An AAS describes asset's relevant characteristics. The level on which the AAS models the asset depends on how the information is used. The physical location of an AAS may be independent of the asset itself (for example, some assets are intangible and therefore can't hold an AAS). It is therefore even possible to use an AAS to describe simple devices that only have limited memory or computing capabilities, such as sensors and mechanical parts like screws etc.

The AAS concept enables communication within the I4.0 architecture. It is an approach to managing information that enables heterogeneous systems and components in different parts of the I4.0 architecture to interact and share information throughout their lifecycles (Figure 3).

AASs are used to create fully digital versions (digital twins) of all of a future factory's assets. They also make it possible for different components to exchange information. They define the structure, management, and security of that information, as well as adaptation to different formats and protocols, including those that are currently in use. AASs will enable new ways of communicating but not establish a new standard that would be the sole way for the entities of a future factory to communicate with one another.

In particular, an AAS is not intended to replace the various industrial automation protocols now used to control assets or

Fig. 2: An Industry 4.0 component [15]

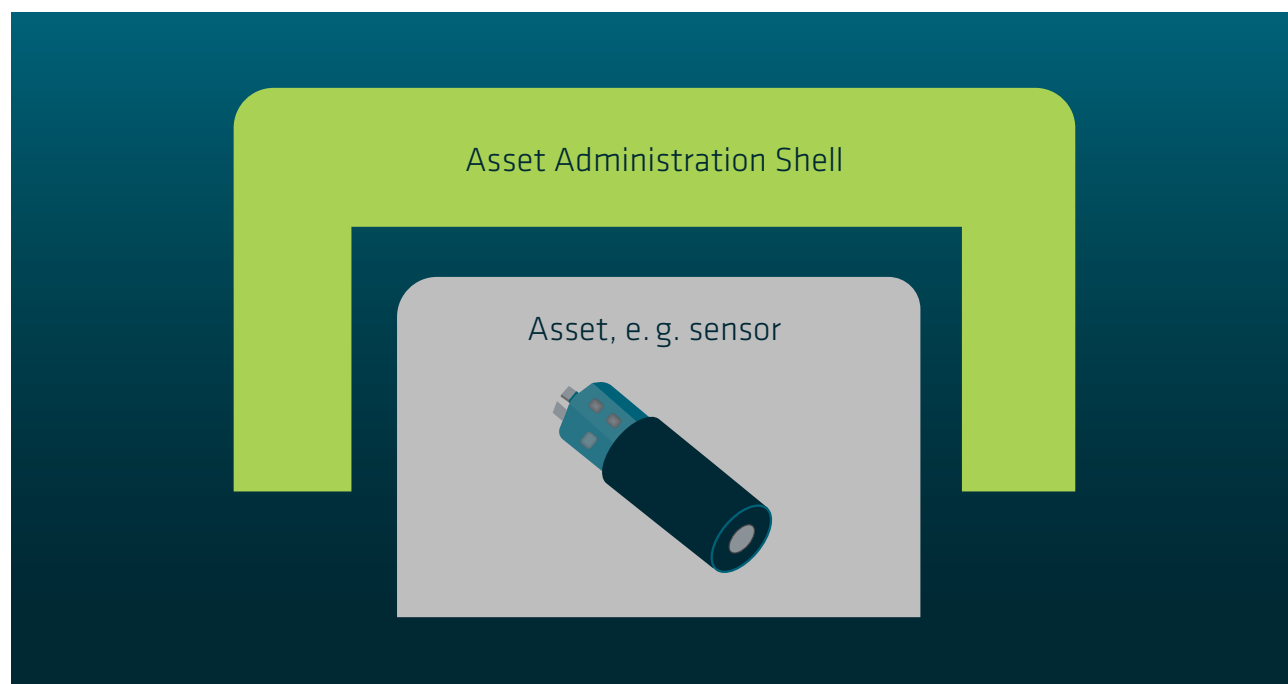

Source: Plattform Industrie 4.0

Fig. 3: AAS over its lifecycle [21]

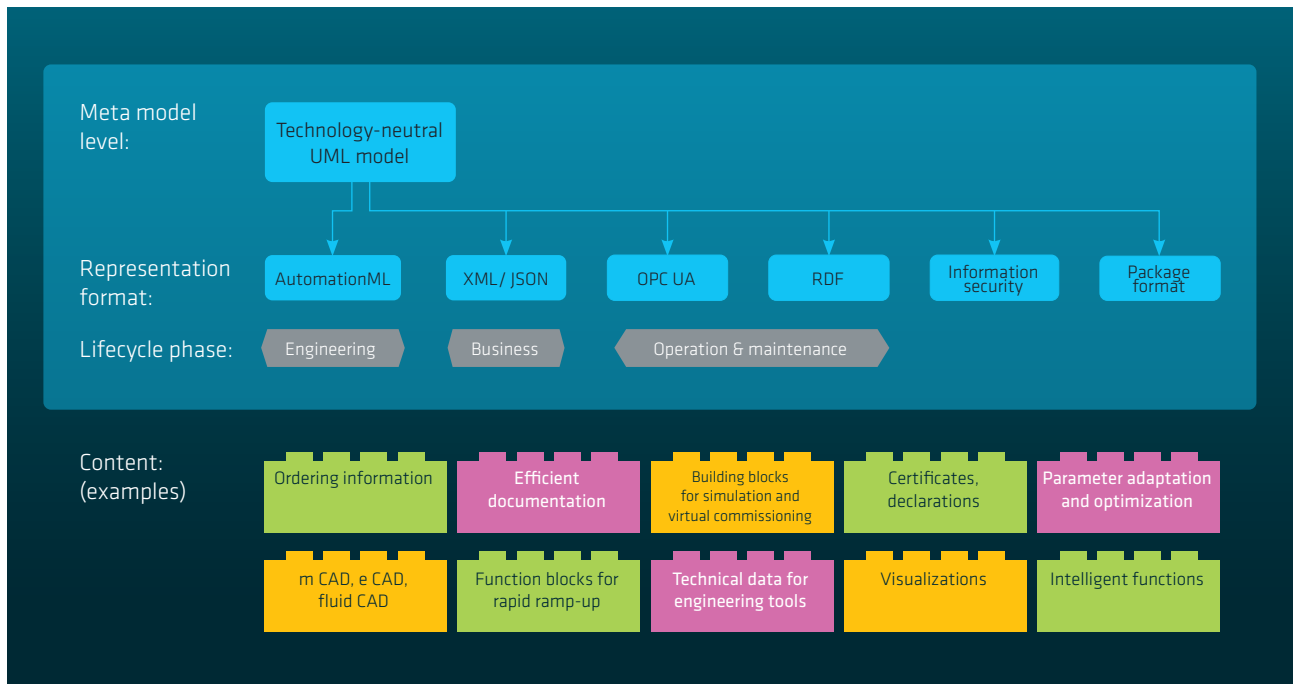

Sources: Plattform Industrie 4.0 and ZVEI

Fig. 4: An automation network described in an AAS "communication" layer [28]

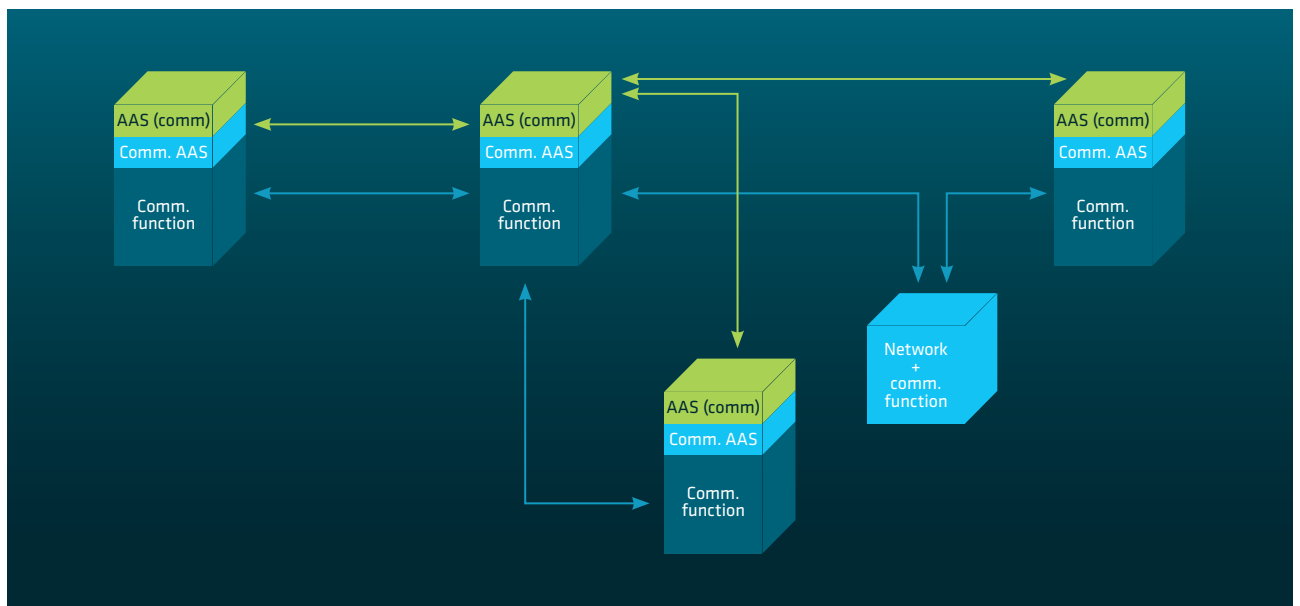

Source: Plattform Industrie 4.0

how they are operated. At the field level, for example, many of these will continue to be used alongside, but independently of, an AAS. Any changes made via other control protocols to information of relevance to AASs are reflected in the relevant AASs.

To sum up, the concept of an AAS has been introduced to integrate several aspects: [9] horizontal integration via value networks; vertical integration, e.g. within a factory or production shop; lifecycle management and end-to-end engineering; and the human beings who orchestrate the value stream.

Entities in the various layers of a factory’s control pyramid are described by AASs that specify the communication system, configuration parameters, status information, and many other aspects (see Figure 4).

There are various aspects involved, including the need to have a flexible, unified description of the network to support interoperability and flexible integration whenever an asset is used over the lifecycle and across functional factory hierarchies.

Each AAS consists of a “header”, which contains identifying details of the AAS and the represented asset, and a “body” containing a large number of submodels. Each submodel is a structured view of properties of data and functions. Every asset, submodel, and property must be uniquely identifiable in compliance with global standards such as ISO29002-5 (international registration data identifiers or IRDIs) or uniform resource identifiers (URIs) [23].

The connections between assets are explained and “static” and “dynamic” relationships are defined in [23].

In the information world:

- Static relationships describe an arrangement as such.
- Dynamic relationships describe how I4.0 components interact during operation.

Relationships are modeled in relationship tables structured like Table 1 below. In the context of 5G networks, a relationship table can be regarded as a list of packet data unit (PDU) sessions (see sections 5.2.1 and 5.8.1).

An AAS may consist of other AASs that are structurally inter-linked to form a hierarchy. In May 2020, Plattform Industrie 4.0 published an updated description called “Details of the Asset Administration Shell – Part 1” [15].

Such an AAS is called a composite AAS. An AAS can belong to multiple composite AASs while also being a composite AAS itself. Despite its structure and relationships, each AAS is considered to be an independent entity. Conversely, components that are not actually separate in the real world should not be defined as independent AASs, but rather as characteristics of the AAS they depend on.

Each AAS has its unique asset ID and consists of a set of submodels which aggregate information that belongs together, as shown in Figure 5. Basic submodels are standardized, while new submodels can be agreed on by partners.

Table 1: Modeling relationships in a relationship table [23].

Relationship	Asset X property	Asset X property	Asset X property
R1	(Asset 1 x M1)	(Asset 2 x M1)	(Asset 3 x M1)
R2	(Asset 1 x M2)	(Asset 2 x M2)	
R3	(Asset 1 x M3)	(Asset 2 x M3)	(Asset 3 x M3)
M	(Asset 1 x Mn)	(Asset 2 x Mn)	

Fig. 5: Possible submodels of an AAS [16][23]

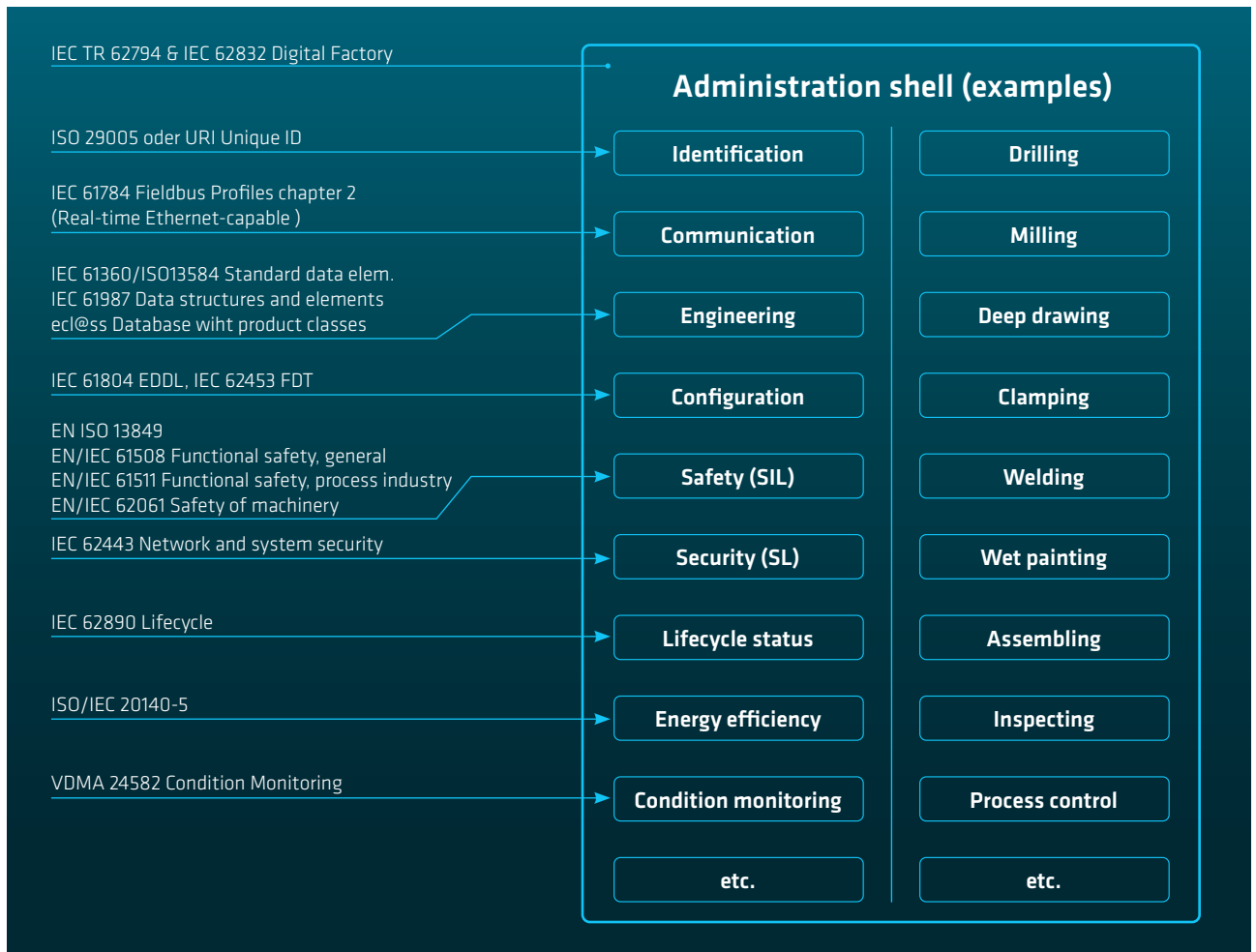

Sources: Plattform Industrie 4.0 and ZVEI

The AAS framework provides flexibility for adding new technologies such as 5G, either as standardized submodels or as a new submodels. Figure 5 shows a set of available standardized submodels that include a communication model for a fieldbus according to [12].

To enable communication among vendors, it is essential to standardize the AASs of the most common elements of future factories. As use cases evolve and more of a component's information becomes relevant to the AAS, the AAS standards themselves may also need to change to accommodate this.

As mentioned above, an AAS isn't limited to physical assets. The single most important asset is information; for example, many contractual aspects contain information that is relevant from the overall operational perspective. There may therefore be a defined AAS submodel for accessing information corresponding to each contractual role.

This said, it is clear that a factory's control functions aren't part of the AAS. An AAS merely provides helpful and necessary information that is accessed by different control functions across the factory, e. g. MES, SCADA, or a machine controller.

Fig. 6: Definitions of types and instances

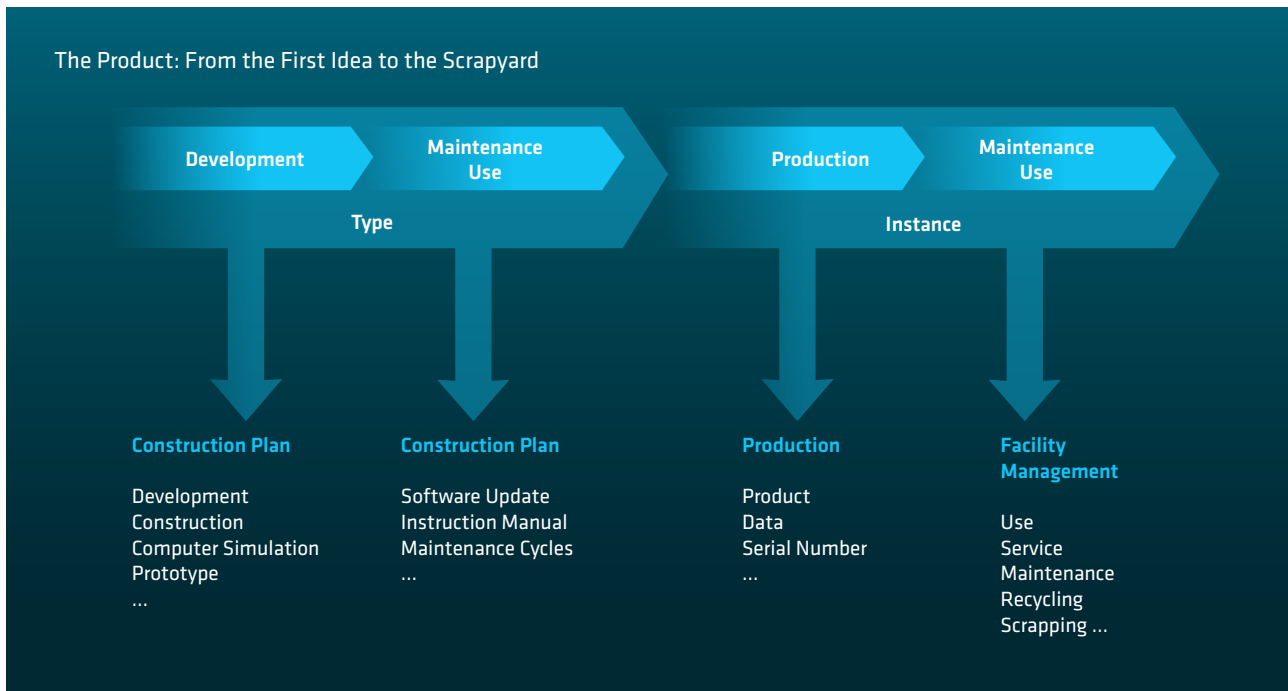

Source: 5G-ACIA

An AAS covers the entire lifecycle of components made in the factory, from designing them all the way through to the end of their useful lives, and defines the various stages involved. It is usually divided into two parts: defining and maintaining a “type”, and producing and using and/or maintaining “instances” of that type. An “instance” is a combination of options that have been defined for a given “type” (Figure 6) The various players in the value chain that are involved in making a component in the factory (sensor manufacturer, machine builder, integrator, factory operator) have similarly structured but distinct lifecycles.

A recently discussed extension of AASs is the inclusion of the source code of scripts (e.g. PLCopen code) needed to execute certain functions. [9]

3.2 Evolution of an AAS into an active AAS

Asset administration shells were originally conceived as basic information pools, but over the last few years this concept has evolved further [15] [17]. Commands and information calls to I4.0 components can now be initiated by a higher-level IT system such as a manufacturing execution system (MES) or an enterprise resource planning (ERP) system as shown in Figure 7. A client in the superordinate IT system initiates an interaction with the server functionalities of the I4.0 systems. This interaction is referred to as “vertical”.

The horizontal (peer-to-peer) interactions are on path to be standardized by Plattform Industrie 4.0 as “active AASs” or “interactive AASs”.

The notion of an active (or interactive) AAS is becoming an important element for building dynamic, self-organizing, self-optimizing, and cross-company value-added networks [20]. Examples include dynamically optimizing the use of produc-

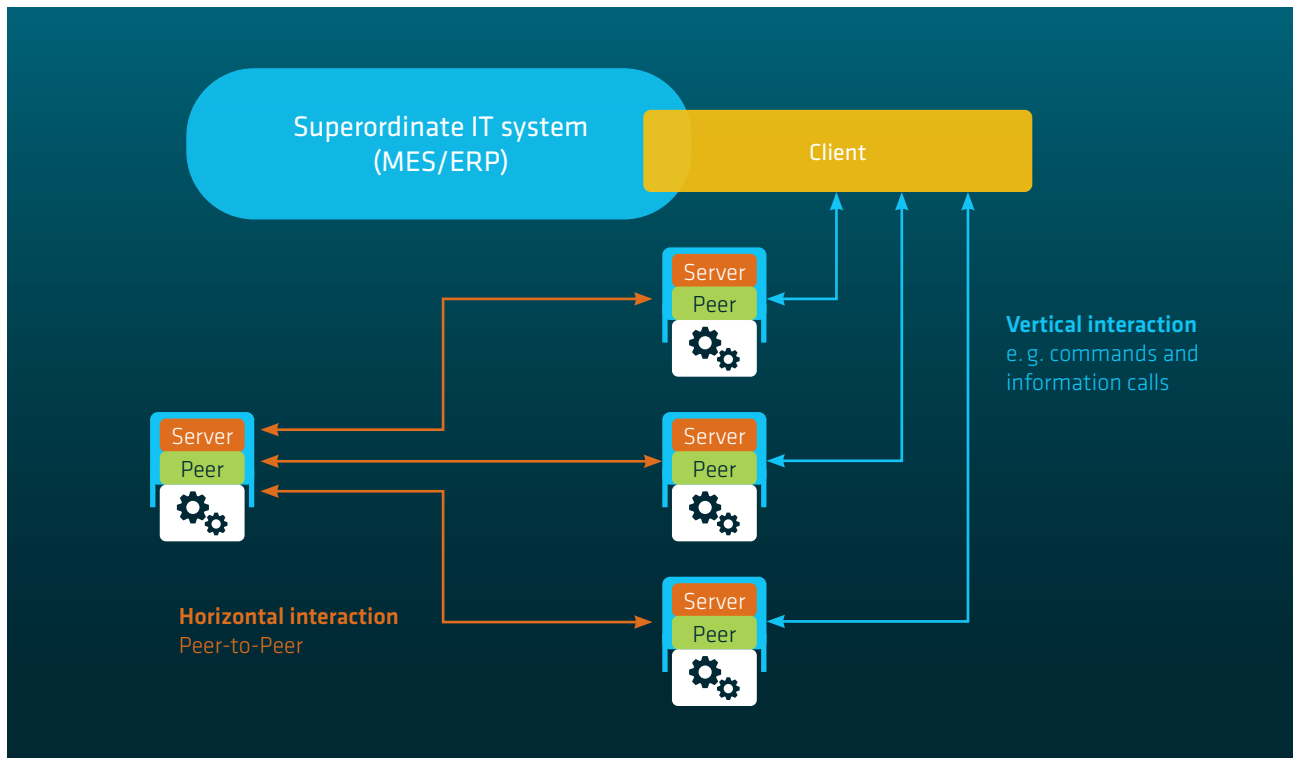
Fig. 7: Horizontal and vertical interactions within I4.0 components

Source: 5G-ACIA

tion capacities, avoiding downtimes caused by equipment failures, order-controlled production, and dynamically orchestrating resources for cost-optimized production of lot size 1.

This requires a certain degree of autonomy on the part of the interacting entities, in other words production systems or their components. In these scenarios, all of the entities are empowered to initiate (horizontal) interactions with others. They thus act as peers, which is why these are called “peer-to-peer interactions”.

An active AAS therefore possesses service-oriented communication capabilities and decision-making functionalities as shown in Figure 8. While the server functionalities execute service-oriented vertical interactions initiated by (external) clients, the decision-making functionality is able to initiate interactions with another AAS on its own. This can take two forms:

- Client/server interaction: The decision-making functionality interacts with the server functionality of a target AAS in a service-oriented manner with commands and information calls.
- Peer-to-peer interaction: The decision-making functionality interacts with the server functionality of a target AAS in a protocol-oriented manner, with the I4.0 components exercising a certain amount of autonomy. This is done for negotiation purposes, for example with the goal of reducing power consumption by self-optimizing.

A particular AAS can interact in both of these ways. In the case of client/server interactions, service-oriented communication takes precedence, while protocol-oriented communication take precedence in peer-to-peer interactions. The submodels of the AAS are accessed in both cases.

Figure 9 shows a different view of AAS integration using “I4.0 language”. This language is used to implement interactions

Fig. 8: Types of AAS functions

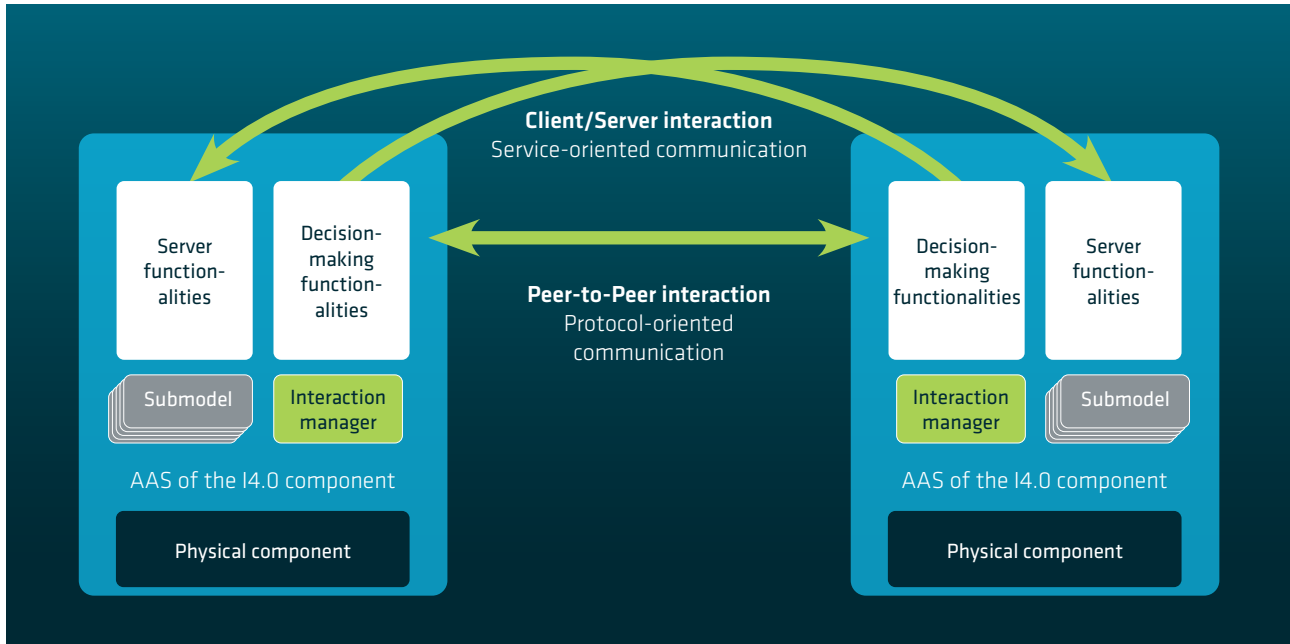

Source: 5G-ACIA

Fig. 9: Active AAS and use of I4.0 language in the ISO/OSI model [15]

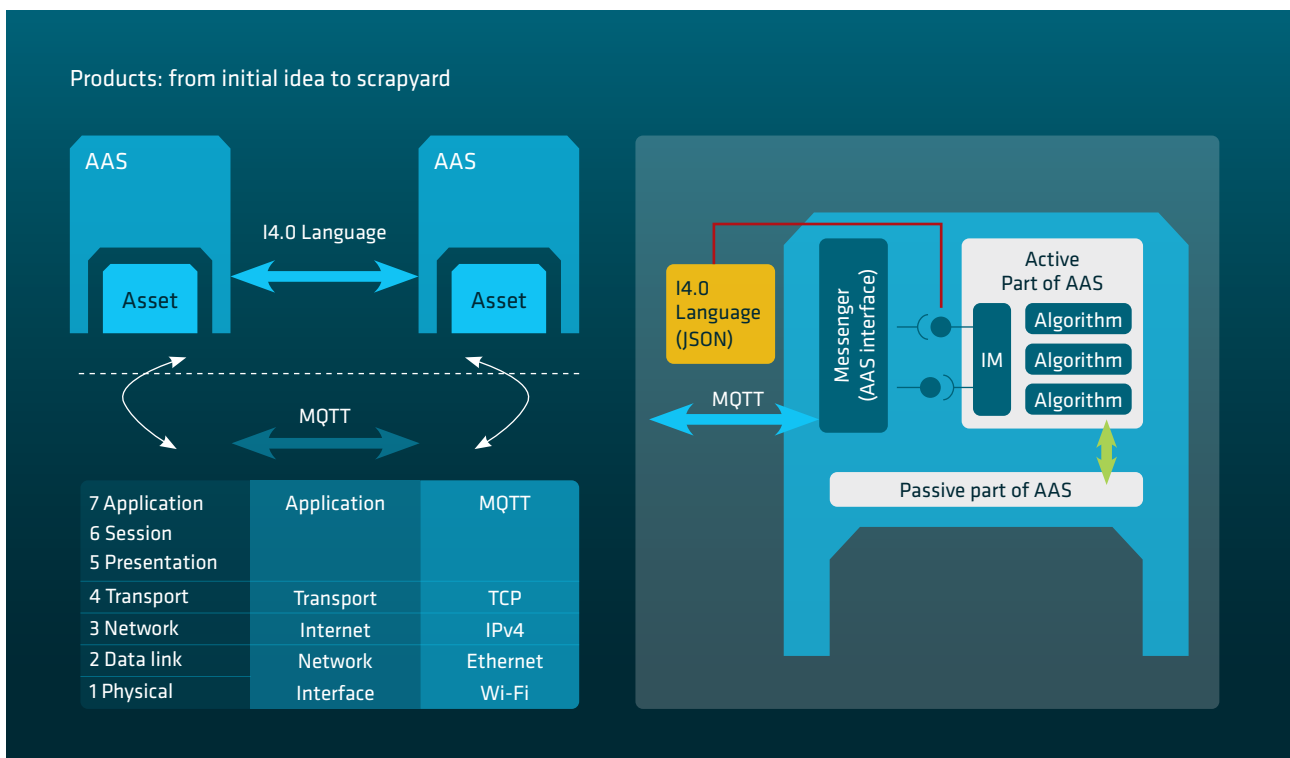

Source: 5G-ACIA

between I4.0 components. The VDI/VDE 2193-1 standard defines this language, which comprises vocabulary, message types with a defined structure, and interactive protocols. It explains the concept of exchanging semantically interoper-

able information and shows how to structure messages and their processes for exchanging information in the context of Industry 4.0, thus constituting the basis for I4.0-compliant cooperation and collaboration.

4 5G Network and System

The 5G system architecture is defined by technical specification TS23.501 of the 3rd Generation Partnership Project (3GPP) [3]. Several deliverables of the 5G Alliance for Connected Industries and Automation (5G-ACIA)—specifically, non-public networks [3], industrial ethernet integration [4], and exposure interfaces [9]—already refer to the 3GPP standard and include a high-level description of a 5G system architecture from the most relevant perspective. These documents also already discuss specific ways to integrate 5G with industrial networks as practical examples of architectural alignment.

This document takes a similar approach, describing the 5G system architecture from the perspective of an Industry 4.0 architectural alignment, which is the main topic here. The focus is therefore on concepts and principles that are applied for designing the 5G system's architecture. Section 4.1 and [1] present the general architectural concepts involved. In the following, we explain the 5G system architecture by examining these concepts in turn.

Please note that some of the 3GPP architectural concepts discussed in this section are actually only relevant to the internal design of 3GPP and included solely for the sake of

Fig. 10: 5G system functional domains and planes

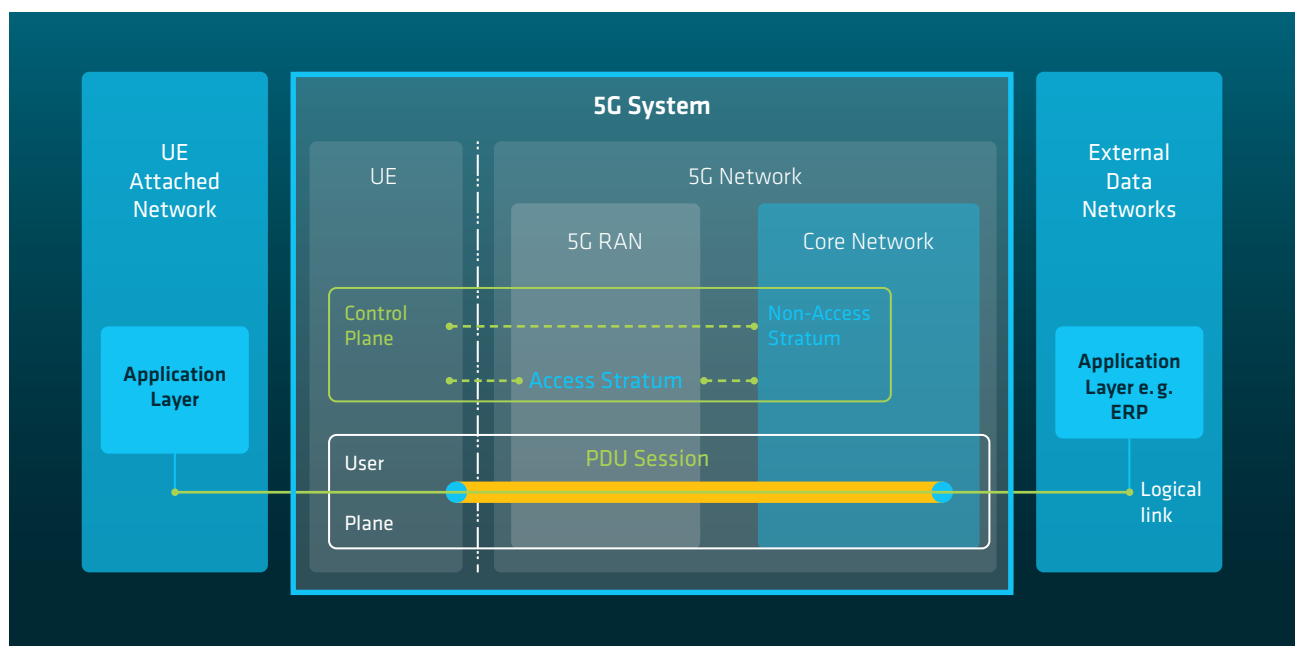

Source: 5G-ACIA

completeness. Their alignment with the Industry 4.0 architecture is discussed further in section 5.2 below in connection with the underlying principles of the AAS.

4.1 Functional domains and planes of the 5G system

Figure 10 shows the high-level functional domains of the 5G system and its primary function of connecting a 5G device, called a user equipment (UE), to external data networks via the 5G network.

For establishing and maintaining connectivity for a UE, which in most cases will be a mobile wireless device, the 3GPP standards define a set of control signaling protocols and procedures. To enable separate development of this kind of control signaling and protocols for conveying user payload data, these two layers have been separated and named the control plane (CP) and user plane (UP), which are shown in Figure 10. This split also permits efficient, independent, standardized deployment and scaling of the CP and UP.

A 5G system can be additionally divided into a 5G radio access network (5G RAN) and a core network (CN). Another architectural principle here is that the 5G RAN and CN are independently designed to the greatest possible extent, among other things in order to allow separate development and scaling. The relationship between the RAN and the CN is flexible; this makes it possible, for example, to create an architecture in which a single CN supports multiple RANs. In addition, UE <-> CN and UE <-> RAN protocols are designed independently of one other in two separate layers called the access stratum (a set of protocols specifically for access technology, e.g. for NR, non-3GPP systems etc.) and the non-access stratum (a set of protocols that are separate from the underlying access stratum protocols).

UP connectivity is based on a so-called PDU (packet data unit) session, which acts like a tunnel linking the UE and a specific data network (DN).

The “logical link” shows the association between application(s) in the UE or connected to the UE and application(s), e.g. ERP in the external data networks. The logical link relates to the end-to-end requirements addressed by 5G-ACIA WG1 and WG5.

The 5G system is responsible for the PDU session layer and corresponding functions such as IP address management, mobility, QoS, policy, security, charging, etc. The PDU session is mounted on top of underlying transport networks, e.g. for radio connections between UE and 5G RAN. This “tunneled user plane” is separate from the underlying transport layer so that network operators are free to deploy different technologies.

The 5G system architecture design is highly modular, as can be seen in the functional domains, layers and planes, which are independent of each other so that they can be separately developed and scaled. Modularity is also evident in how the functional domains are split into functional entities called network functions (NF) belonging to the 5G system control plane, which are described in the following sections.

4.2 5G system architecture with a core network in a service-based representation

Each functional domain comprises one or more separate network functions (NF), which are shown in Figure 11. Some of the NFs interconnect via named point-to-point reference points, which can be implemented as protocol-based interfaces. This applies both to the UP interfaces and to all RAN/CN interfaces. 3GPP has defined the CN architecture as a service-based architecture (SBA). The functionalities of some CN NFs are available via an exposure interface as a set of services that can also be deployed by other authorized NFs. The reason for using a SBA is to help optimize cloud-based 5G implementations.

The NFs shown in Figure 11 are part of the 5G system and described in [1]. Not all of them are required in all cases, e.g. the location management function (LMF), the time-sensitive

Fig. 11: 5G architecture with service-based CN architecture representation

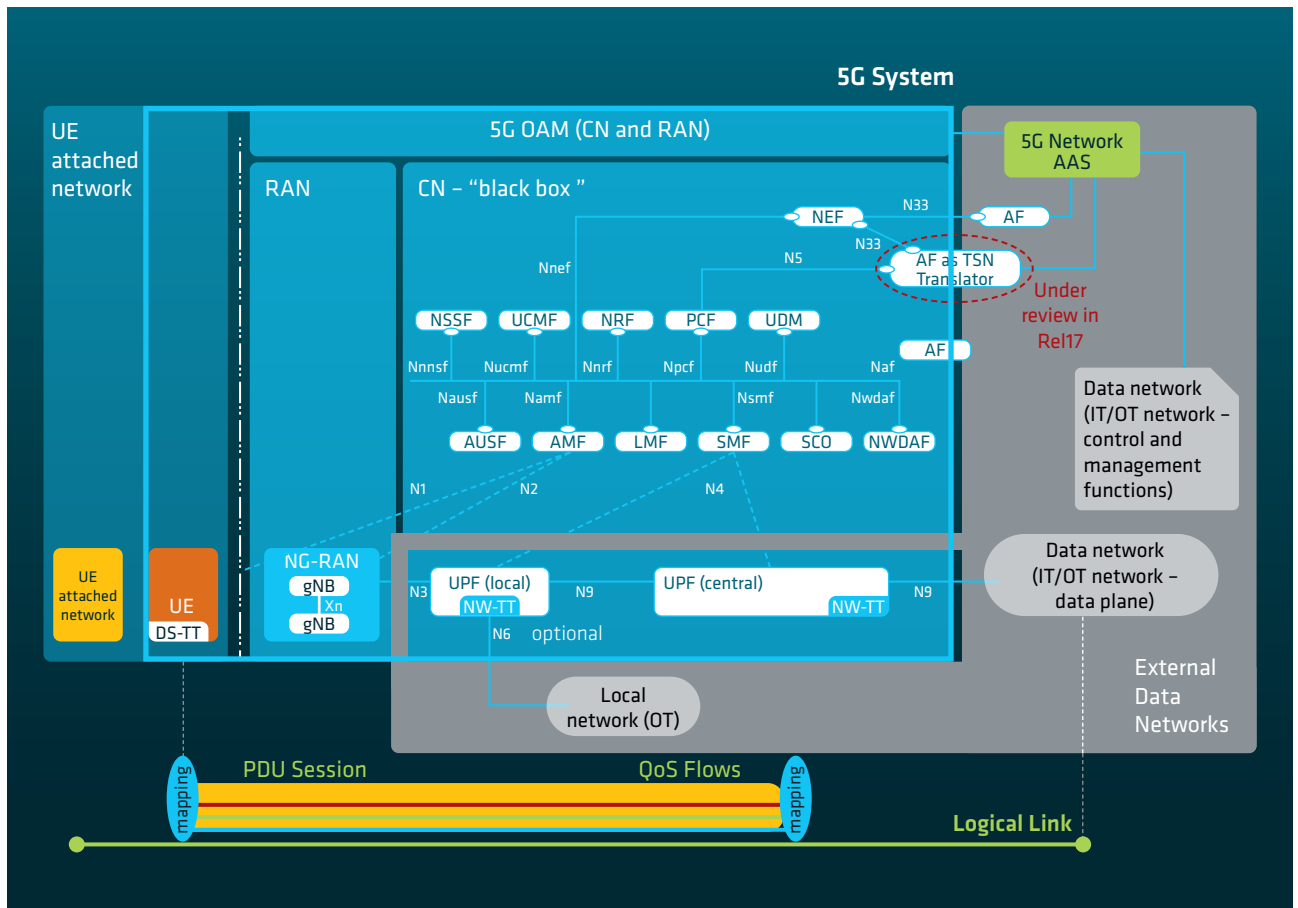

Source: 5G-ACIA

networking (TSN) related functions, or the network data analytics function (NWDAF). These are part of the 5G system but not necessarily visible to the factory network or flexibly deployed objects.

To illustrate the architectural principle of supporting access to both local and centralized services, Figure 11 shows two user plane functions (UPFs). A UE can generate multiple parallel PDU sessions for the same or different data networks (DNs).

Support for full or partial network function virtualization (NFV) is another design principle of the 5G system architecture. All NFs may be implemented as a physical network function (PNF) or a virtual network function (VNF), and a 5G system deployment can contain any combination of both.

Figure 11 doesn't show the details of the next-generation radio access network (NG-RAN), showing only the gNB (next-generation node B = 5G base station) and the reference point Xn used to interconnect neighboring gNBs. As defined in [4], each gNB NG may be additionally divided into a central unit (CU) that is connected via the F1 interface to one or more distributed units (DU).

In addition, the 5G System is designed to have flexibility for controlling network access based on radio access technologies and frequency bands, directing a UE to a specific public or private network, serving the UE with a different set of core network functional entities, and routing user data to specific service networks, with all this being accomplished in a differentiated manner via logical separation. The 5G network components can therefore be tailored to serve specific groups of

users and applications based on their subscriptions and/or (optionally) the configuration of the UEs.

The application function (AF) is designed to enable factory operators (for example) to add customized applications for accessing the functionalities of the 5G system.

In a trusted domain, the network's owner can implement AFs that have direct access to the NFs of the CP.

4.3 Mobility and roaming between different 3GPP network operators

The previous sections have been devoted to describing the architecture of a 5G network, presenting NFs and the interconnections among them that are needed to support the services and mobility of UEs operating in the served area. One important capability that can be enabled in 3GPP networks is that of providing services to users who have subscribed to one network but visit another. This functionality is called roaming. The involved networks are referred to as "home" and "visited" networks.

The 3GPP system operates in such a way that, as far as possible, the end user or application experiences the same level of service regardless of whether a UE is served by its home network or a visited network. The 5G system works in much the same way in both cases. Many other things also need to be considered, however. In terms of network architecture, many of the interfaces already discussed need to be extended between the two networks, which may have different security domains (i.e. sets of security features). Some new NFs have been introduced to make these interconnections possible.

Since roaming is a key functionality of 3GPP systems, [1] presents a number of applicable architectural reference models. No new architectural approaches are introduced there, however, and they are therefore not discussed in greater detail here either.

The 5G system supports a wide variety of access network (AN) types besides 5G RANs. These are called non-3GPP ANs. Release 15 of 3GPP defined so-called untrusted access networks (UANs), and release 16 introduced trusted access networks (TANs) and wireline access networks (the "last-mile" data transmission technologies for connecting business and residences, such as xDSL, PON, and Cablelabs networks). The 5G design principle of decoupling access and core networks to the greatest possible extent makes it more straightforward to enable a core network to support such non-3GPP ANs, requiring only minimal modifications to accommodate their differences from RANs.

Essentially, the UAN lets a UE obtain an IP address from the AN it is connected to, for example a Wi-Fi network. This can also be done to establish connectivity to the 5G system, either without any kind of authentication whatsoever or with authentication that is independent of the 5G network. This connectivity is based on IPsec IKEv2 (the Internet Protocol Security suite for Internet Key Exchange V. 2), which defines both data and control planes.

[1] defines multiple examples of other architectures applicable to non-3GPP ANs such as Wi-Fi, but only 5G RAN is considered here. Additional studies are needed prior to incorporating the parameters required for integrating untrusted access networks and wireline access networks into the 5G system.

4.4 Network slicing

Network slicing is a new concept that has been added to 5G so that many separate logical 5G networks, each of which provides a different set of services to a different group of UEs, can be flexibly supported within the scope of a single 5G network deployment. To enable this multiplexing, many new capabilities have been incorporated into the 5G standards. For example, the 5G system architecture now includes a network slice selection function (NSSF) entity that selects the correct network slice for each UE.

Figure 12 below shows an example of network slicing for an industrial facility. There are three different slices that use the same 5G RAN to access local services such as other components of the factory automation system, central services such as the Internet or public network voice services, or a combination of both. The cloud-shaped icon in the figure includes the relevant part of the 5G core network and the data network from which the service is provided.

The top slice is customized to meet the factory's particular needs and has two parts. The first part, which is only available locally and is completely private, is used by devices that exclusively access local services. The second, optional part (dashed line) provides access to central services such as public voice services.

The other two slices are examples of public network slices that can also be used by the facility. One is used for surveillance cameras, with access to the video stream being restricted to the party responsible for providing security services, and the other is a mobile broadband slice that a contractor uses to transmit augmented reality data for enhanced visualization in asset maintenance. As shown in the figure, access to local services can also be provided from these slices if appropriate and wished.

Network slicing essentially involves logically splitting network resources into separate slices for independently providing different services. Slicing can be implemented with either physical or virtual separation of resources, e.g. NFs, or a combination of both. In principle, each network slice includes all of the functions of a full-fledged 5G system. There are many ways to achieve this, however, and it should not be assumed that the split will always take place at the logical level of architectural elements, in other words at the NF level. Consequently, network slices should not be treated as separate architectures. Slicing is a function that can be provided by a 5G system installation. A typical phase in the lifecycle of a network slice is shown in Figure 13. Slices can be flexibly created, reconfigured, and deleted depending on business or servicing requirements. This figure shows the various phases of a slice's lifecycle and should be kept in mind in connection with the discussion of 5G AAS submodels in section 5.8 below.

4.5 Non-Public Networks

Non-Public Networks (NPNs), also known as private or campus networks, are an important concept in connection with the industrial domains introduced by 3GPP release 16, since they make it possible to build a dedicated 5G network within an industrial facility. Non-Public Networking doesn't actually introduce any new architectural concepts besides those presented in the preceding sections. Nevertheless, there have been many protocol-level additions to the 3GPP specifications for this new network type, which in any case isn't intended for use by the general public and therefore doesn't necessarily need to comply with all of the legal requirements for public networks. The capabilities needed to support them are described in section 5.30 of [1].

Due to the great relevance of private or campus networks to use cases in the context of the Industrial Internet of Things (IIoT), another 5G-ACIA white paper has already discussed this capability [3]. It introduced two main new NPN types, one of which is isolated from the public network as shown on the left of Figure 14, while the other, which is not separate from the public network, can be deployed in three different ways as shown on the right. Depending on the scenario, these can be either implemented with a standalone NPN (SNPN) defined by 3GPP or integrated into the public network (which is then called a public network-integrated NPN or PNI-NPN).

An isolated or standalone NPN deployment ensures dedicated resources and physical separation from other networks. A RAN network can be also shared by different standalone and public NPNs. This enables flexible customization to meet the needs of OT-specific use cases. Connecting such a standalone private network to a public network is optional and not a requirement for operating the NPN. Public network services can still be accessed, e.g. for logistics use cases that require connectivity outside NPN coverage, but this requires a separate installation. This deployment scenario can use the standalone NPN functionality defined by 3GPP.

Even when a NPN and a local public network are implemented together while sharing resources at different levels, it is still possible to logically separate them. Joint operation with public networks also facilitates access to the latter, e.g. for global

Fig. 12: Network slicing at an industrial facility

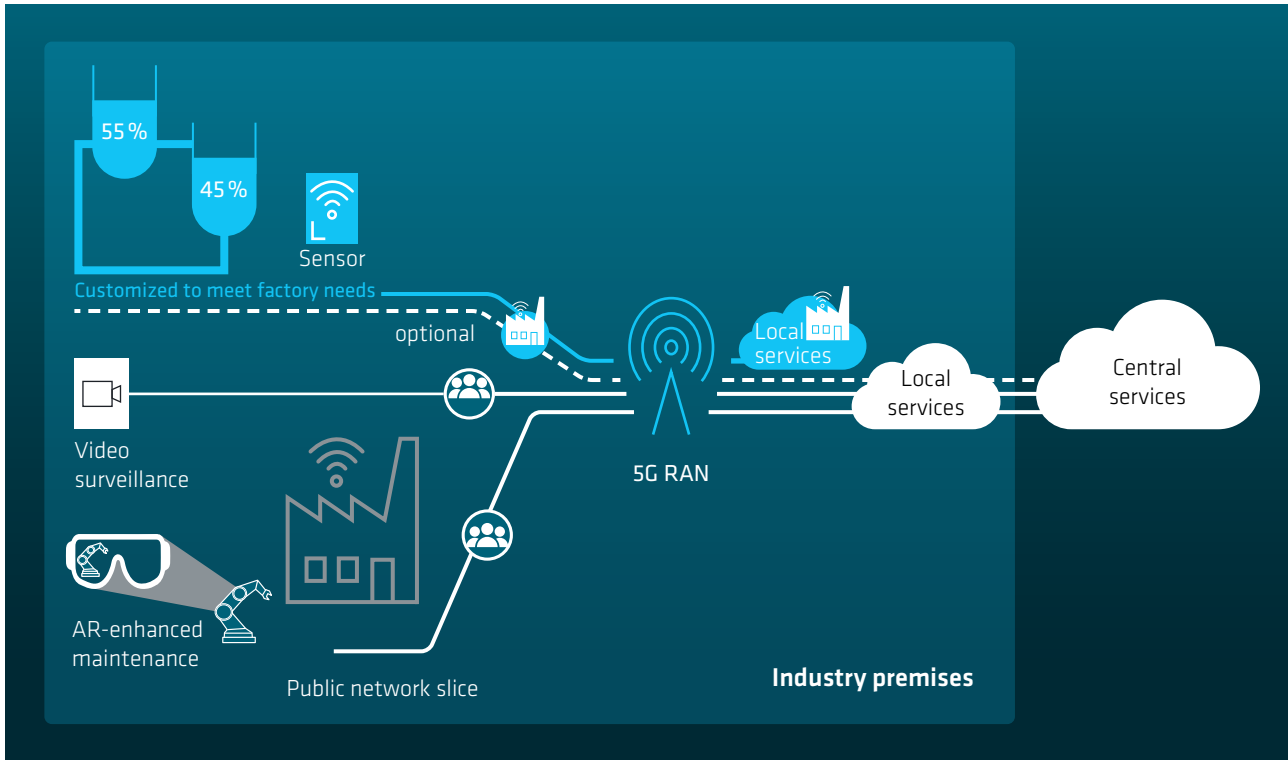

Source: 5G-ACIA

Fig. 13: Lifecycle of a network slice

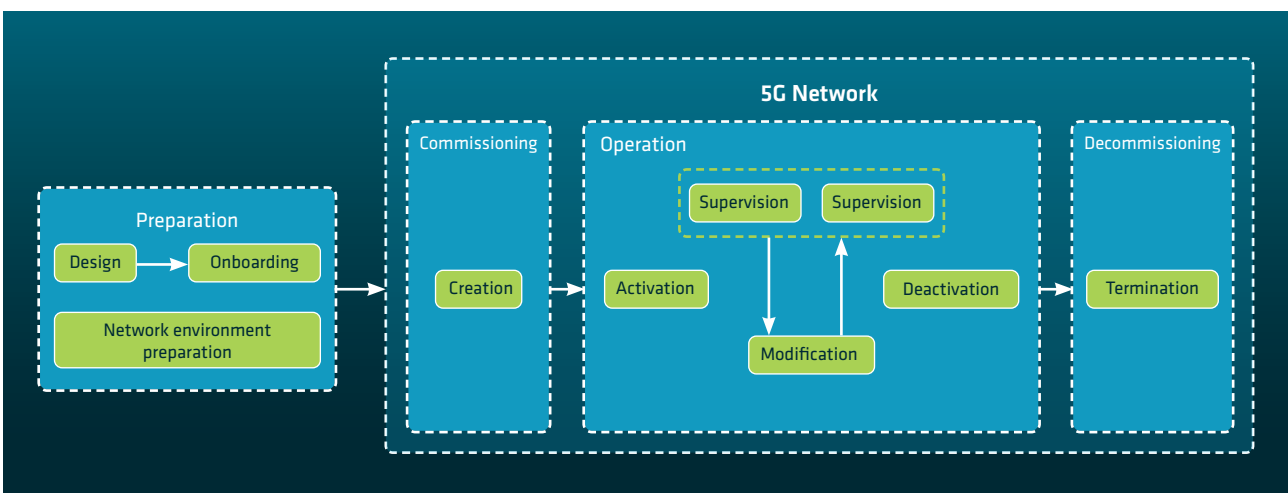

Source: 3GPP

Fig. 14: Four examples of NPN deployments in conjunction with public networks [3]

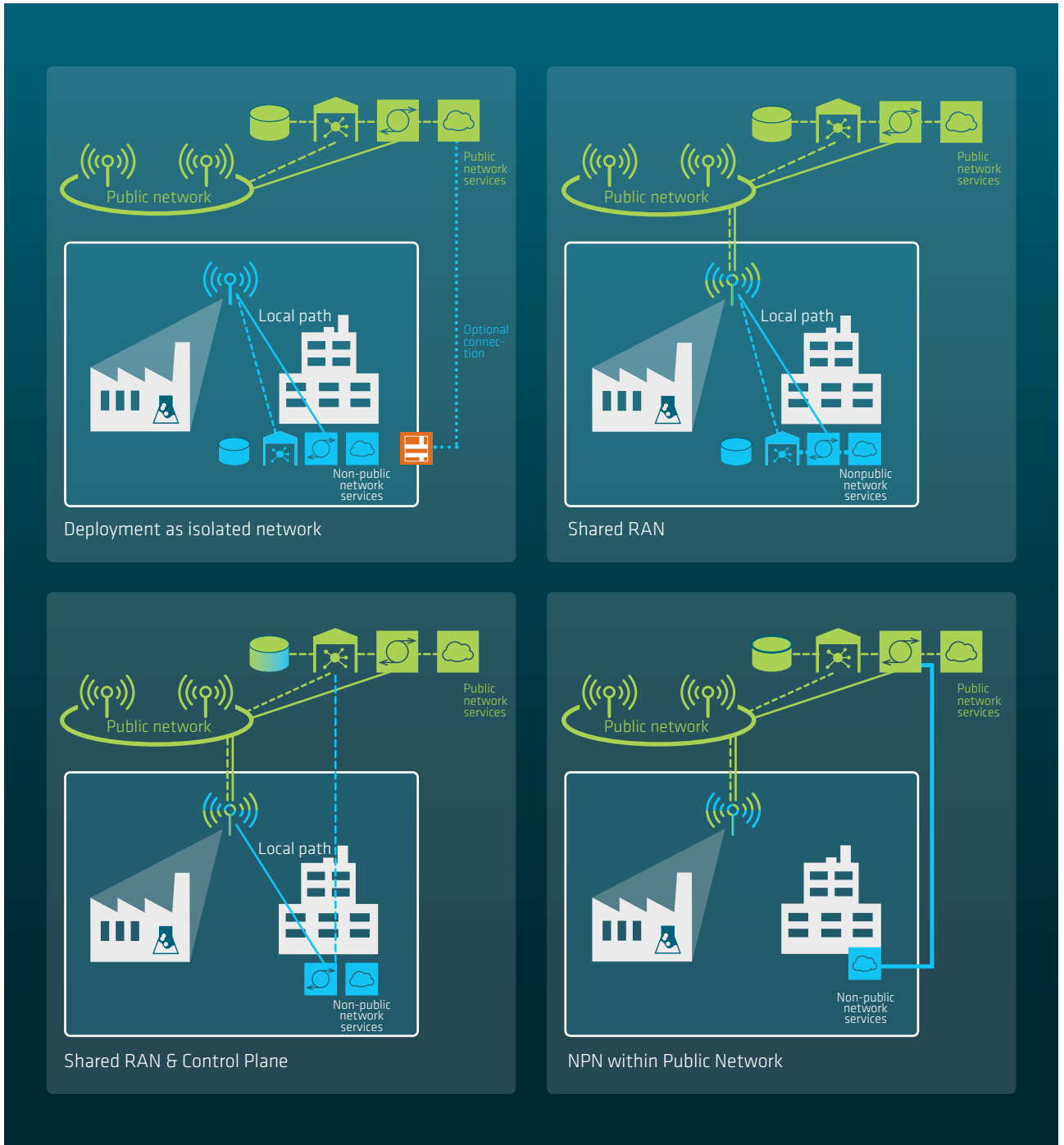

Source: 5G-ACIA

roaming. Sharing of resources and outsourcing of network operation enable the OT to focus on its core business. The downside is that flexibility and the availability of features are tied more tightly to the public network offering.

4.6 Alignment considerations at the architectural level

Where the alignment of the 5G system architecture with Industry 4.0 is concerned, two key questions need to be asked. The first is what a 5G system architecture is used for in a given industrial environment, in order to decide whether it is practical and beneficial to align it with an industrial architecture such as RAMI 4.0. The other is about the kinds of components used to build the 5G system and how these will present themselves to the industrial system.

The answer to the first question is that 5G will be a key part of the infrastructure for operational communication in the conventional sense as well as flexible Industry 4.0-type communication across the layers of the automation pyramid, both of

which need to be consistently enabled. The main functional motivation for aligning these architectures is to ensure and seamlessly integrate communication capabilities. Although deeper integration may be considered, e. g. for cloud computing infrastructure, the motivation to do so is not inherently functional; for the time being, therefore, it is merely an option for the future.

To answer the second question, it is essential to understand the full range of products available from all manufacturers. This is difficult because the situation is still evolving. One thing is clear, however, namely that not all interfaces can be used to connect to products from other vendors. It will therefore not be feasible to separately purchase NFs from different sources. Commercial 5G offerings will come with some level of well-tested “black box” packaging, much like previous 3GPP system generations. What can be said with confidence is that the 5G network and 5G UEs will be available from different vendors. For the purposes of this document, this may be enough. The 5G network will also come in two parts: a 5G radio access network (RAN) and a 5G core network (CN). The question as to which level should be addressed is discussed in greater depth in Chapter 5.

5 5G Asset Administration Shell

5.1 Requirements for a 5G Asset Administration Shell definition

As described in section 3.1, an AAS is a key component of the Smart Factory and the Industry 4.0 architecture for ensuring integration across system boundaries and interoperability across value chains. It supports the notion of working with digital twins of all of a factory’s assets.

The information provided by the AAS doesn’t need to be stored on the terminal or device or 5G network nodes like base stations. An identifier can be used, e. g. 2D bar codes or RFID tags to reference an AAS hosted on a central, highly available database of the company, supplier, or factory oper-

ator. Recently a URL tag has been introduced for facilitating access via the Enterprise Cloud.

A 5G network is already a complex constellation of different devices and network functions hosted by computers. A 5G network consists of distributed devices such as antennas, one or more baseband processing units, and CN functions hosted on partly virtualized IT equipment. The description of the 5G network in the form of an AAS must take this complexity into account in well-structured AAS submodels.

In the following section, prospects for the 5G going beyond a purely physical, device-related description are discussed.

5.2 Considerations for developing a 5G Asset Administration Shell

There are many ways to define an AAS for a complex 5G system. It is necessary to decide which level the description should address and how the various attributes should relate to and depend on one other.

A 5GS should be modeled as an AAS on a level that best suits the functional purpose for which 5G will be deployed in a future factory. In addition, attention should be paid to the kinds of physical, virtual (e.g. computing platforms or software in general), or contractual roles it will play among other components. This includes lifecycle aspects. It should also be asked whether separate 5G AASs will need to be defined from these perspectives. Alternatively, some of these may be best described as attributes of the communication dimension. The following sections address these aspects in greater detail.

5.2.1 5G AAS from a functional perspective of 5G as a communication system

A 5G system serves as wireless communication technology. This is the functional context of the 5G AAS. Describing a 5G system as a single AAS may not be practical, however, since it is a large, complex system comprising many functional entities. The possibility of introducing additional divisions should therefore be considered. From the overall functionality perspective, 5G provides a means for two endpoints to communicate via a network. The 5G assets to be described could include the communication link between the two endpoints, the communication equipment at the endpoints, and the overall network.

A study published by the “Plattform Industrie 4.0” [11] proposes a similar approach for conceptualizing communication capabilities that is based on an AAS definition. Here interest focuses on the communication link and its endpoints, which are hosts in the network. The network itself is viewed more as an enabler whose internal structure is uninteresting, since it is considered from the perspective of the 5G management

and operating system and the provided exposure interfaces (“exposure” of a network means making its capabilities easily available for customers and partners to innovate on). The study proposes that an AAS description should mainly focus on its functionality, which in turn drives its communication capabilities. The content of the 5G AAS is maintained by various entities within the 5G system, such as 5G UE, 5G RAN, and 5G CN.

5G-ACIA proposes using two basic AASs or digital twins called 5G UE AAS and 5G NW AAS. Additional information can be defined as submodels as part of both basic types.

According to this logic, the 5G AAS description is based on functional perspectives that should include the following:

- **5G UE AAS:** This describes the endpoint of the 5G link at the device end, which is the 5G UE, and considers its functionalities, capabilities, and performance as defined by 3GPP. The corresponding 5G-related AAS could be called the *5G UE AAS* and is a submodel of a 5G-capable device.
- **5G network AAS.** This is the enabling networking function, which includes all nodes and functions in the 5G RAN and CN that are not part of *5G-capable IIoT devices*. This 5G NW AAS includes structured information on the following:
 - 5G link network endpoint. This describes the logical function of the endpoint of a 5G link on the network side. In a 5G system, this is the UPF acting as a gateway to the factory data network (DN). The UPF supports multiple functions such as packet routing and forwarding, packet inspection, TSN support, etc. 5G UPF will be deployed on capable computing hardware and provided as an integral part of a 5G system or perhaps orchestrated to an edge computing node that is part of the OT IT network. The relevant information might be linked to the AAS description of the host device or virtual entity.
 - The specific configuration and derived measurements have to be reported via the 5G network AAS as described in Chapter 6. Some or all of the functionalities may be supported in a single instance of a UPF.

- 5G link. This subsection of the 5G network AAS describes the characteristics of communication between two endpoints. In 3GPP terms, it maps to a single PDU session. PDU sessions differ from “logical links” and terminate at the 5G UE and the 5G core function called the UPF. The 5G link description includes references to the description of the 5G link network endpoint. The UE doesn’t actually know the details of the configuration of the UPF, because this is managed by the 5G core functions based on, for example, the QoS settings. In general, the 5G core can even change and add new UPFs while running.
- A single 5G link could also be connected to multiple UPFs, for example to provide redundancy.

5.2.2 5G AAS from the physical perspective: what is 5G equipment and where is it located?

The 5G system and associated equipment are physically installed in, say, a factory. The AAS can include definitions of the associated physical conditions and activities. These can include things like where the equipment is located, how it is operated and connected, and how much power it required to run. This is referred to in the following as the 5G topology.

The physical dimension also includes the use of radio frequencies. These can naturally vary greatly depending on the manufacturer and deployment. An operator can also provide 5G services to a factory without actually installing any physical equipment there apart from the communication device itself. Almost all of the components of a 5G network installed inside the factory can be integrated in a single box, or else each 3GPP-defined functional element can be separately implemented. Various roles are involved until the factory or a production line is up and running: examples include 5G infrastructure vendor, 5G-capable device supplier, factory integrator, and factory operator. Some parts of the AAS description may also be modified depending on the responsibilities and phases of the particular system’s lifecycle. Due to the enormous possible variability, it is not feasible to exhaustively cover this aspect here.

5.2.3 5G AAS from the virtual perspective: shared computing environments

From virtual presence perspective, it is important to consider how 5G will merge with the computing platforms of future factories. Most 5G implementations use virtualized computing environments, and the 5G system architecture standard also covers service-based architectures, partly in order to standardize the further development of these capabilities. 5G itself also provides access to edge computing capabilities. There are two possibilities: either the 5G network AAS can describe these capabilities, or else they can be considered to be internal to the 5G network. If they are part of the description, they should be characterized in meaningful terms, e.g. how much computing capability is requested, reserved, utilized, or provided etc. All of these things depend on the particular implementation and deployment scenario.

Since it is expected that the first 5G factory deployments will run on platforms provided by infrastructure vendors, this aspect is not addressed here at this time.

5.2.4 Contractual aspects of defining the 5G AAS

With regard to the primary function of the 5G system, we can identify two contractual players: the communication service user and the communication service provider. It is important to distinguish these contractual roles if and only if they are separate legal entities. If there is only one such entity, there is no point in creating this separation. Here there is a clear link to terminology used in 3GPP, such as the PLMN operator, NPN operator, subscriber and so on, but there are also many aspects that would make full mapping difficult to achieve. Examples of contractual aspects are service level agreements or warranties. A simple approach is to include these as attributes of the relevant functional aspects in the extended description of the 5G network AAS.

5.2.5 Lifecycle aspect

The lifecycle of a 5G system deployed in a factory could be described using the terms defined for the AAS. Most of the work involved in creating a definition would be focused on creating a “type”, since the “instance” is a representation of what was built or implemented in a deployment. The 5G “type” should naturally include all capabilities needed to operate and maintain the system when an “instance” is implemented. These capabilities should be adequately defined following the suggestions given above in this section.

From an asset administration and management perspective, the 5G network and 5G UE differ with regard to the value chain players involved. A 5G network is built and deployed by an equipment manufacturer, system integrator, or service provider. After deployment, the 5G network is handed over to the factory operator, who manages the network.

By contrast, 5G UE used in a factory can be supplied by multiple vendors. A system integrator will combine a variety of devices with sensors/actuators, controllers, and IIoT applications from different suppliers to build composite AASs and hand these over to the factory integrator and operator. The process of deploying devices and handing over operations is not static, since manufacturing and automation processes are constantly refined and improved. New devices will therefore frequently be commissioned and integrated and/or existing devices reconfigured or decommissioned.

Due to these differences, 5G UEs and the 5G network must have separate AASs with a many-to-one relationship. The 5G UE AAS must be designed in such a way that it can be nested in composite AASs, whereas the 5G network AAS is self-contained and therefore doesn't need to be nested in this way. The 5G-NW functions will run on dedicated or virtualized computing systems and have to be linked to these entities. This is reflected in the topology description and must be maintained through the lifecycle.

Fig. 15: Lifecycle of a factory [18]

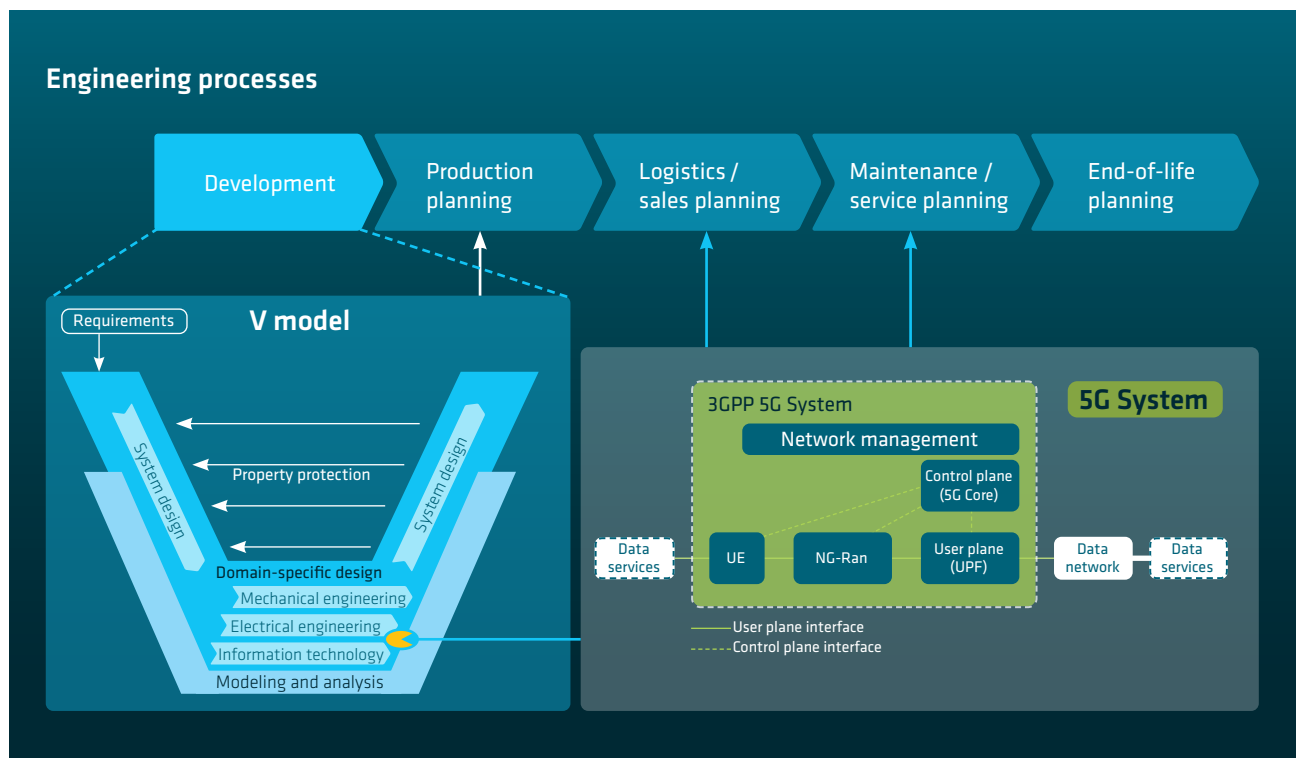

Source: 5G-ACIA

Fig. 16: Stakeholders accessing 5G network AAS

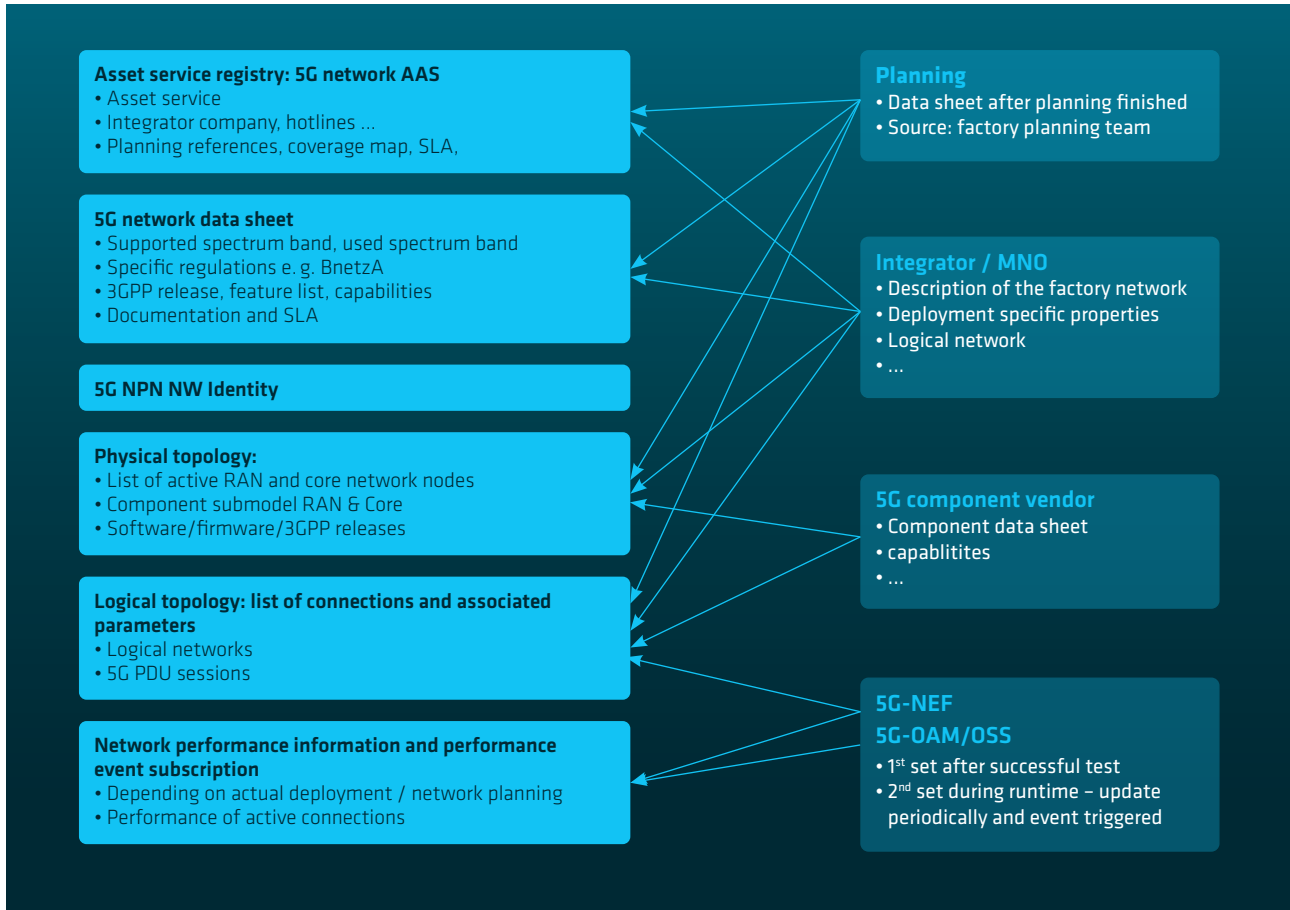

Source: 5G-ACIA

Because many parties are involved over the course of the lifecycle of a factory or production line, the 5G UE AAS and the 5G network AAS documentation can be divided into static and dynamic parts. The static part describes the capabilities of the 5G parts as delivered (= data sheets) while the dynamic part is updated by various players during the course of the system’s lifecycle.

The information captured by the 5G AAS must be managed by different teams during the various process steps. The results of network planning must be added to the topology description and specific configuration after the production cell has been successfully tested and the radio links are in place. During actual production, the 5G network then adds reports and status updates to the corresponding parts of the 5G AAS. It may be necessary to carefully define appropriate

access rights to prevent processes from overwriting information without authorization. Figure 16 shows, on a tentative basis, which parts of the 5G network’s AAS are managed by which stakeholders.

5.3 Definition of 5G UE AAS

Assuming that the 5G-UE (5G user equipment) is a functional part of a 5G-capable device and integrated in an industrial device, a combination of UE and device is shown in Figure 17.

The 5G UE AAS submodel includes all functions defined by 3GPP as part of the UE. These functions are implemented on a chip or in a module or device as a system-on-a-chip (SoC).

Fig. 17: Illustration of the relationship between a physical world asset and 5G UE

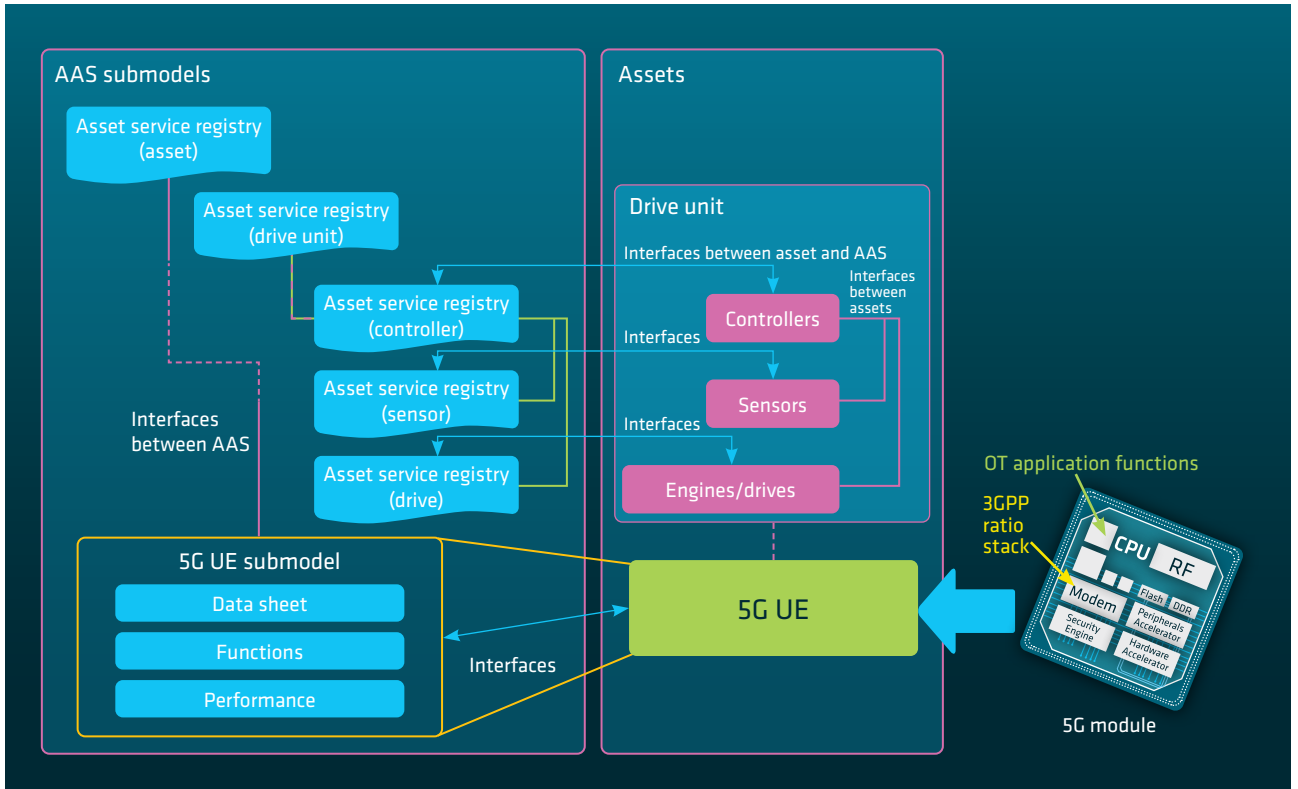

Source: 5G-ACIA

Fig. 18: Internal structure of the 5G UE AAS

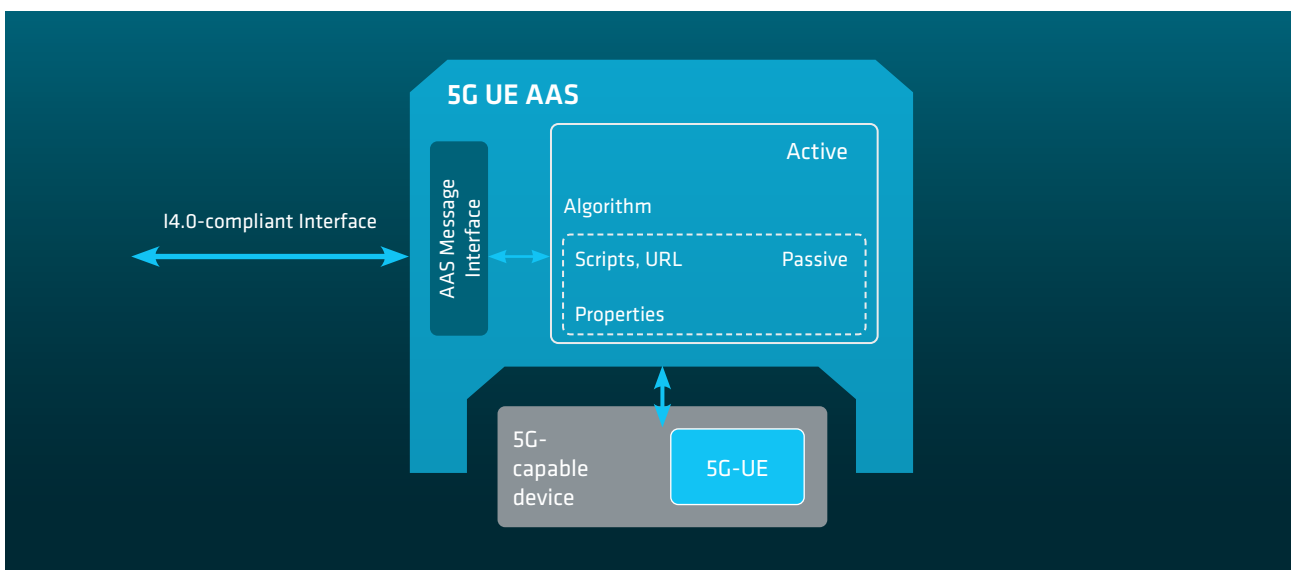

Source: 5G-ACIA

Each SoC includes many additional functions that are not covered by the 3GPP definitions and must therefore be described by the supplier or manufacturer in additional submodels of the IIoT device.

As shown in Figure 18, the 5G UE AAS consists of a passive part, an active part, and a message interface that supports Industry 4.0-compliant communication.

The passive part of each 5G UE AAS submodel contains properties that can be read and modified via the message interface (e. g. API), in addition to read-only properties. The active part also holds algorithms for peer-to-peer communication with other AASs as described in section 3.2. Changing certain properties can trigger various interactions with the UE or other AASs (e. g. the 5G network AAS or 5G UE AAS). The logic of these interactions (the sequence of interactions, processing of the results of each individual interaction, official supervision, etc.) is contained in algorithms in the (inter-)active part of the 5G UE AAS. Example use cases are described in Chapter 6.

Figure 18 shows the 5G device. A 5G device AAS that has been developed and deployed by a device manufacturer will include the 5G UE AAS. An integrator can only be exposed to the 5G device AAS that inherits all of the capabilities (i.e. parameters and algorithms) of the 5G UE AAS.

As explained in section 3.1. the definition of industrial AAS calls submodel elements that describe such an arrangement “static relationships”.

Dynamic relationships describe how I4.0 components interact during operation. Most of their properties can require interactions with the 5G UE or other AASs in order to yield meaningful values.

Some of the submodel elements of the 5G UE AAS either remain unchanged or are only infrequently updated during the lifecycle of an UE. Examples:

- UE identity
- UE attach and connection status
- Permanent equipment identifier

- Authentication certificate
- 3GPP terminal class identifier
- UE radio capabilities (data sheet)

Other properties are frequently changed while the 5G-UE is operating, adding to the network load between the 5G-UE and the storage location of the 5G UE AAS:

- Network access restrictions / geofencing
- Connectivity QoS monitoring subscriptions
- Connectivity QoS monitoring results and events
- Location event subscriptions
- Location results and events

Additional radio network loads caused by frequent updating (e. g. every second or millisecond) of submodel elements over the wireless link have to be calculated, and increase the 5G campus network’s capacity requirement.

5.4 Definition of a 5G network AAS

Due to the inherent flexibility of service-oriented 5G architectures, some functions—UPF, for example—can be instantiated multiple times and distributed to various computing platforms around the factory (see Figure 23 in section 6.5).

The 5G system comprises many individual physical and logical function blocks such as antennas, base stations, cables, and 5G core network servers. 5G also supports splitting the base station (gNB) into a central unit (CU) and a distributed unit (DU). Antennas can be connected by fibers in the fronthaul portion of a telecommunications system consisting of optical hubs to enable structured deployment. 5G core network functions can be orchestrated and deployed on multiple host engines, e.g. to provide redundancy. Maintenance and management functions are performed by the 5G-OAM subsystem, which is also called the 5G operation support system (5G-OSS).

The proposed 5G network AAS comprises hierarchically structured submodels describing each node and its location within

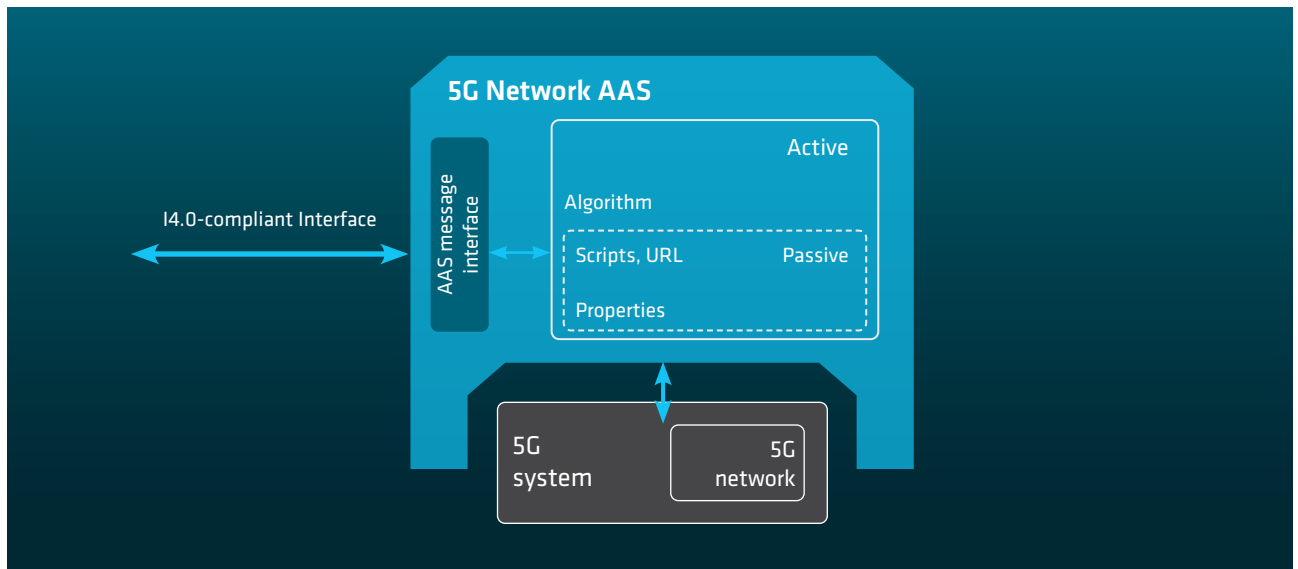
Figure 19: Breakdown of the 5G network AAS

Source: 5G-ACIA

the factory. It enables any required updates to these parameters and reports their new states.

Regarding the perspectives of 5G AAS discussed in 5.2, the 5G system can be described either as an n-port distributed L2 and L3 switch or as a TSN bridge with a single AAS. The 5G network AAS is the distributed “switching fabric” that is configured by the 5G network management and controlled by the 5G core network functions.

As discussed above, all UEs representing the data port are described as independent 5G UE AAS models, while the UPF forms part of the 5G network AAS.

As shown in Figure 19, the 5G network AAS is broken down into a passive and an active part plus a message interface that uses Industry 4.0-compliant communication methods.

Similarly to the 5G UE AAS, the 5G network AAS has properties that can be either read and modified or read only. It also contains executable programs that include a runtime engine (see section 3.2). When certain dynamic properties are modified, this can trigger various interactions with all nodes of the 5G NPN, with the 5G OSS, or with other AASs (e. g. the 5G UE AAS). The logic of these interactions (sequence of inter-

actions, processing of the results of individual interactions, government monitoring, etc.) is described in algorithms integrated in the active part of the 5G network AAS.

Figure 19 depicts the 5G system as a single asset, which masks the complexity of a 5G network comprising a wide variety of nodes and functions. The 5G network AAS can be either used as a standalone AAS or integrated with other network AASs (like a factory network management system).

The properties of the 5G network AAS that either never change or are only infrequently updated over the lifetime of the 5G NPN are:

- 5G NPN NW identity
- Network KPIs (aligned with IEC TC65C “industrial networks”) [28]
- Network topology, including the list of deployed network elements
- Radio and network capabilities (supported spectrum, transmission power, connection types, etc.)

In order for some properties to deliver meaningful value, they need to interact with a variety of network functions, 5G OSS, and other AASs. Of vital importance is the list of 5G links,

which reflects all PDU sessions and data flows with associated QoS profiles for all 5G UEs served by the 5G network in each case. Other AASs or industrial IoT application functions can manage the connectivity of each UE via the 5G network AAS. Consequently, the attributes associated with that list of properties must also be modifiable. Management of connections is a frequent activity for many UEs in the network. These attributes reflect:

- A list of logical networks or PDU sessions, underlying QoS flows, and associated parameters (e. g. address ranges)
- A list of active connections and associated parameters (UE IDs, addresses, QoS attributes, performance, etc.)

Depending on the deployment scenario, the 5G network AAS contains different levels of information. The details of the shared information depend on an agreement (such as a service level agreement (SLA)) with the 5G network operator.

Additional standardization is required by the Plattform Industrie 4.0 to unify a basic set of information and profiles for different deployment scenarios.

5.5 Logical Interfaces to the 5G network AAS/5G UE AAS

This section provides a brief overview of the possible interfaces between the 5G AAS and the 5G system.

The 5G system consists of various physical and logical components. The 5G core network controls the data flows and connections between the 5G device endpoint (the UE) and the data network (DN) endpoint (the user plane functions or UPFs).

The 5G network management system (NMS), which has a service-based architecture, is responsible for configuring the physical and logical nodes of the 5G core network domain.

The 5G system is able to communicate the network's status and events and obtain configurations from outside via a

standardized API (application protocol interface). It enables connections via a northbound interface to an external system and a southbound interface to the various 5G network functionalities.

The 5G system and I4.0 AAS are able to exchange information via API as shown in Figure 20 (for a detailed description of the 5G system, please refer to Chapter 4). A specific API has to be added to manage the information in the 5G network AAS and the 5G UE AAS. Both of these use standardized data models and enable uniform access to all relevant data across all lifecycle phases independently of the specific representation models used, for example AutomationML [19] for engineering or OPC-UA [27] for operation and maintenance.

In future versions of the 5G network AAS, the 5G system will be configured by AAS logic enabled by an "active AAS" with integrated smart functions. To support interactions between the AASs of different entities, the 5G network AAS and 5G UE AAS must be able to talk in an I4.0-specific "language".

The AAS began as a basic information pool consisting of simple files that stored relevant information in a highly reliable manner in an agreed data structure, for example using JSON description models.

Version 2 of the AAS definitions introduced an API to unify access to data. A recently discussed extension of the AAS also contains the source code of scripts, e. g. PLCopen code that is required to run certain optimization functions. This recent extension will be standardized by Plattform Industrie 4.0 as "active AAS".

A virtualized representation of all components together with an AAS description of all relevant radio network components is an elegant way to encapsulate the 5G system's complexity. Two special cases require further analysis. When a 5G UE is first integrated into an manufactured product such as an engine, all of its properties would be described in its AAS. This would also include radio parameters if the UPF functionality could be implemented either in a standalone device or in combination with an industrial gateway that includes a firewall.

Fig. 20: Virtual representation of all 5G network components, functions, and KPIs in AAS

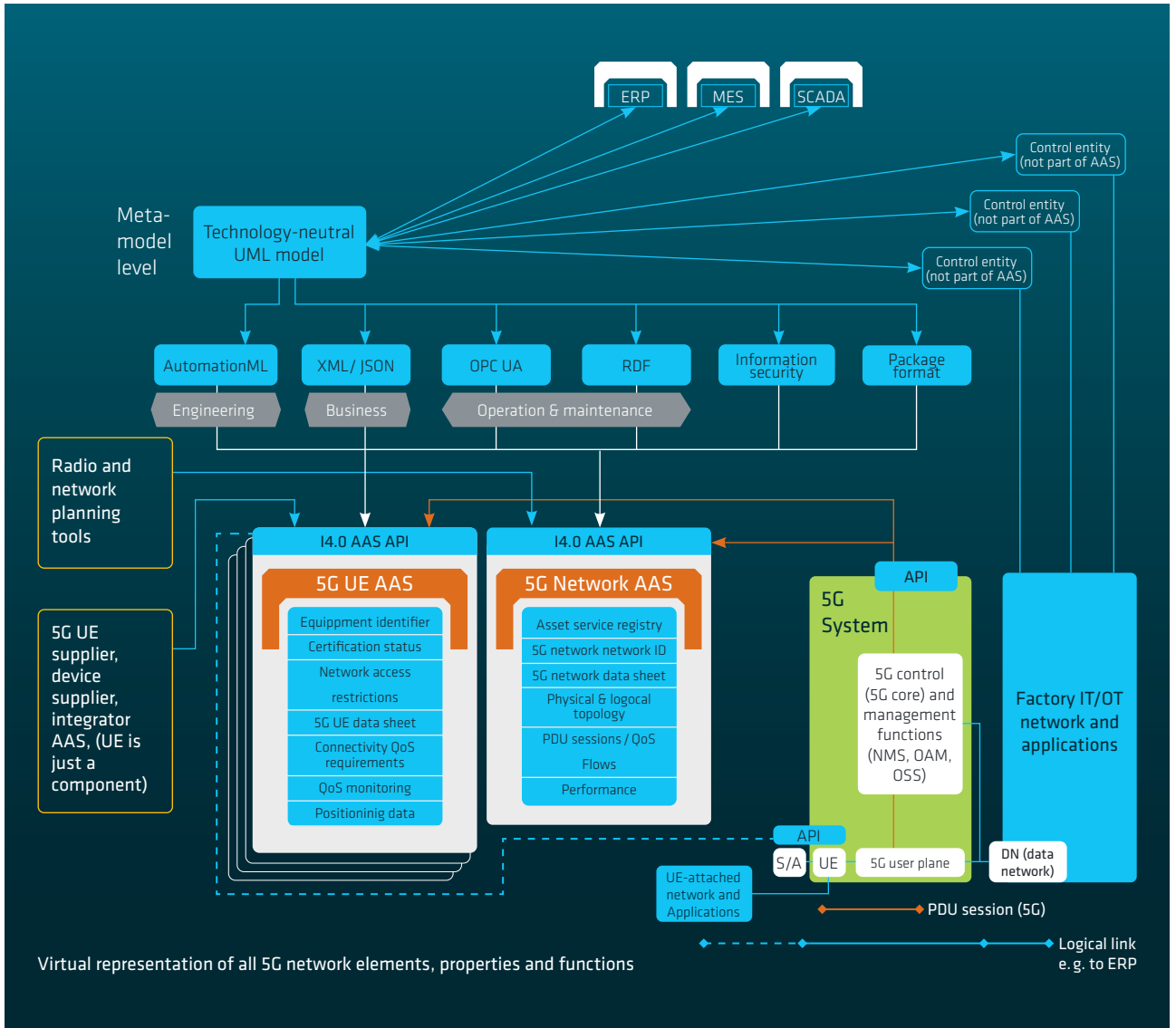

Source: 5G-ACIA

The goals of the factory network management system (FNMS):

1. Administration, monitoring, and diagnosis of industrial networks
2. Reading of diagnostic data provided by industrial Ethernet protocols
3. Support for joint network management of IT and OT factory networks
4. Topology monitoring
5. Support for the FCAPS model of the International Organization for Standardization, including features such as centralized software updates, identification of risks and abnormal behavior by networks, and visualization of networks and network elements

Application scenario:

- Visualization of network status to ensure availability
- Central administration and diagnosis of TSN-capable devices and networks
- Administration of the international standards on industrial communication networks covered by IEC 62443 (see also the 5G-ACIA white paper on security aspects [10])

Integration with

- Device profiles
- Northbound interface to Scada and MES systems

5.6 Changes to 5G infrastructure

The 5G network AAS describes the 5G network in terms of its topology, communication links (PDU sessions, QoS flows), data sheets, documentation, network planning records and so forth. Not all information may be available for all deployment scenarios (see section 4.5), depending on who deploys and operates the network and related SLAs between parties.

All 5G-enabled devices used are similarly described by the 5G UE AAS.

Factories, production lines, or production cells are dynamically updated as required to improve or introduce new products

or redesigns or to improve efficiency. The frequency of such updates varies across industries. New approaches for more flexible production and greater product customization may shorten the intervals between production line updates.

New machines and sensors will be added, making it necessary to update the descriptions of communication networks.

Different scenarios involving updates of and changes to the 5G system can be considered. Here are some examples of developments that may lead to AAS updates (also of static parts, for example if the NW is upgraded for a new 3GPP release).

1. Addition of new 5G-capable devices or changes to existing ones
 - Updating of the 5G UE AAS
 - Updating of the 5G network AAS (link list and PDU sessions)
 - Relocation
2. Changes to the 5G network infrastructure
 - Upgrading to a new 3GPP release, which may add new features to the UPF functions and to some extent redefine the QoS
 - Upgrading of new features, e. g. localization services like those being studied in 3GPP SA2 for Release 17. "Enhancement to the 5GC location services phase 2 (5G_eLCS_ph2)"
 - Addition of new antennas to improve coverage, redundancy, and service quality. Updating of the topology and node list. Changes to antenna data sheet and specific information on antenna characterization and orientation.
3. Changes to 5G network settings during operation
 - Reconfiguration of communication links such as QoS or addition of new 5G connections will require updating of the 5G network AAS and related entries in the 5G UE AAS.
 - Deployment of different UPF functions on different host computers to boost capacity and redundancy. It can be accomplished with careful planning, but

may affect the 5G network management system and require updating of the 5G network AAS.

- It is possible that not all dynamic adaptations of the 5G system are reported to the AAS since the 5G system acts as a multiport switch. The impact of new radio beam management technologies requires further study; this may become important if it becomes necessary to optimize radio interference between networks.
- Flexible communication across the hierarchies of a factory using 5G network slices

This means that AAS information has to be updated during the factory's lifecycle (across development, engineering, operation, and maintenance to final scrapping and recycling). Any changes must be documented, and no references to other connected asset management shells may be deleted.

This is the fundamental purpose of the interactive AASs described in section 3.2.

A lifecycle entry is a time-stamped information entry associated with an asset. In this report, the proposed 5G AAS doesn't reflect the mechanism of the AAS description for updating the 5G network and its functionality. This is a matter for further study and can be handled similarly to updating the legacy wiring system.

5.7 TSN Integration with 5G networks

Time-sensitive networking (TSN) is a set of communications standards specified by the corresponding IEEE task group [15] for wired deterministic communication in an industry network consisting of TSN components such as TSN bridges and end stations.

"TSN capabilities" can be included in any AAS, e.g. as a submodel, for identifying the corresponding TSN-capable component. A submodel possesses the properties required to establish TSN connections with other TSN-capable I4.0 components. The properties include static parameters that

are typically only configured once during initial setup, such as "IP", "port", "VLAN-ID", and "VLAN priority", as well as active parameters such as StreamIDs [26] that designate different TSN flows.

The 5G network constitutes a logical TSN bridge, which has been described in 5G-ACIA white papers [6] and [8]. In order for a 5G network to appear to TSN management entities as a logical TSN bridge, it must present the same set of parameters as any other TSN bridge. This functionality is implemented by a TSN application function (AF) within the CN. The 5G network AAS must therefore include a TSN capabilities submodel just like any other AAS of any TSN bridge.

The ongoing joint project "IEC/IEEE 60802 Time-Sensitive Profile (TSP) for Industrial Automation" [16] is investigating a centralized management entity. A TSN AAS can act as a digital twin of such an entity, supporting the idea of working with "digital twins" of all of a factory's TSN-capable assets. Applying the I4.0 AAS concept makes this seamless integration, configuration, and management of TSN infrastructure in industry networks feasible.

5.8 Properties that must be covered by 5G AAS submodels

Two new types of submodels have been proposed in connection with the 5G architecture consisting of the 5G RAN, 5G core network, and 5G UE (user equipment) as described in Chapter 5.

- 5G network AAS
- 5G UE AAS

This section provides a tentative list of the parameters and information of a 5G AAS submodel that are essential for describing a 5G network and 5G UE. Analysis is mainly being performed from the functional perspective (see section 5.2.1), the physical perspective (section 5.2.2), and to some extent also the lifecycle perspective (section 5.2.5).

More detailed consideration of the contractual aspects (section 5.2.4) is an aspect of the 5G-ACIA work item “guaranteed service level specifications” and not covered by this report.

More in-depth work is also needed on the implications of virtualizing the 5G core and radio (see the initial analysis in section 5.2.3).

Work still remains to be done to define the level of detail that users of the 5G AAS will require, because some items involve quite complex substructures that could be described in considerably greater detail if necessary.

The corresponding Plattform Industrie 4.0 working groups are responsible for finalizing the standardization of the models and descriptions.

Some information is static while other information will need to be updated across the various phases of the lifecycle and incorporated into the description below.

5.8.1 5G Network AAS

The 5G network is described in the current version of the document as a black box that works like a high-performance n-port L3 or L2 switch or like a TSN bridge with distributed endpoints. The orchestration of 5G network functions is not addressed in detail.

The 5G network AAS must include the most important information required to build a digital twin of the 5G system as such, including operational parameters and information.

The properties of the 5G network AAS are accessible from, for example, an IIoT application via the northbound AAS API or from other AASs via the active part of the AAS. Some properties are static (unmodifiable) with configured values, while others are dynamic. Over the lifetime of the 5G network, the dynamic properties are regularly changed by various 5G network functions (NMS including 5G OSS or OAM), by IIoT applications, or by other AASs. These modifications are not executed in real time. Any real-time sensor, actuator,

controller, or manager data are exchanged via PDU sessions without traversing the AAS.

In addition, the 5G system provides solutions for determining the position of the 5G-UE. This information is provided by the 5G network and shared with the UE. This enables the 5G-UE to add location information to the 5G UE AAS. Generally speaking, it is also possible to supplement the 5G network AAS with a submodel containing information on the positions of all connected UEs that are not addressed in the 5G network AAS example below.

The 5G network AAS can contain the properties below, some of which are from the 5G-ACIA white paper on 5G network exposure capabilities [9].

1. 5G network data sheet
2. NW identity in the format:
 - a. PLMN-ID or
 - b. NPN-ID (999 + private network ID or NID registered with the Internet Assigned Numbers Authority (iana))

The next section describes the network’s topology:

3. List of active RAN nodes:
 - a. Node 1 (e. g. baseband units)
 - b. Node 2: (e. g. antenna units)
 - c. etc.
4. List of CN nodes:
 - a. CN node 1: (e. g. a server that hosts CN functions)
 - b. CN node 2: (e. g. redundancy node)
 - c. etc.
5. List of logical networks (network slices or virtual LAN)
 - a. Logical network 1
 - b. Logical network 2
 - c. etc.
6. List of active 5G links (PDU sessions):
 1. Attached UE (how many UEs are still connected)
 2. List of active connections (PDU sessions)
 3. 5G link A (PDU session A)—including QoS requirements etc.
 4. 5G link B (PDU session B)—including QoS requirements etc.
 5. etc.

Fig. 21: Example of a hierarchical 5G AAS and information sources during its lifecycle

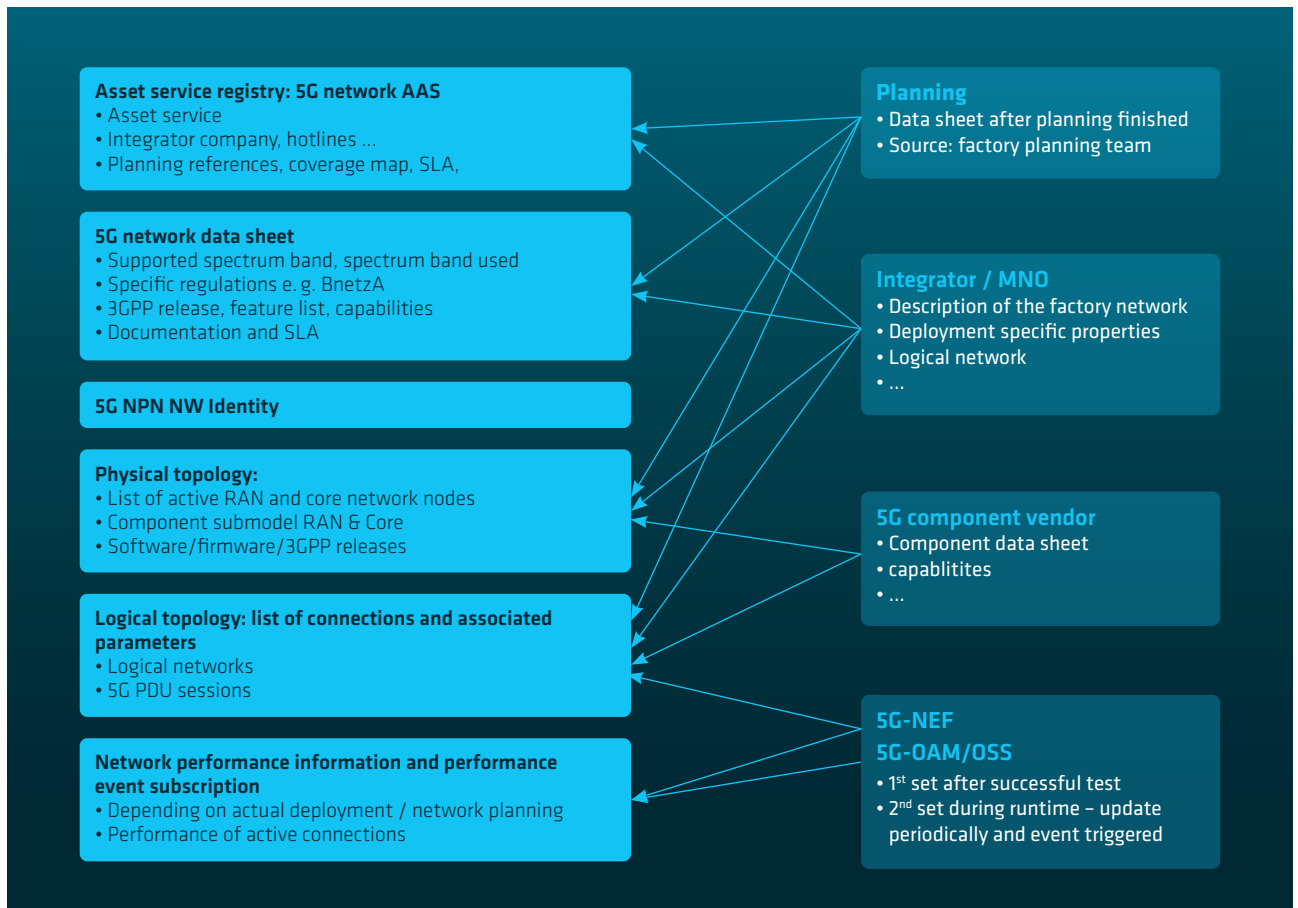

Source: 5G-ACIA

This section deals with performance reporting and monitoring:

7. Network performance
 - a. Data throughput (average, max, min)
 - b. Data latency (average, max, min)
 - c. Utilization of installed capacity over a time period D
 - d. 5G link A (PDU session A)–including QoS flow measurements and additional KPIs exposed by 5G
 - e. 5G link B (PDU session B)
 - f. etc.
8. Performance event subscription

Additional information related to the 5G system must be provided by extensions or additional submodels such as SLS, documents, nonphysical aspects of the above description, etc.

Figure 21 depicts the hierarchical structure of the 5G network AAS and visualizes the information source. Different stakeholders provide information and update it over the lifecycle or runtime of the 5G connections.

5.8.2 5G UE AAS

3GPP defines the functionalities of the radio and higher-layer protocols required for an end-user device called UE. A 5G-capable device AAS may be a compound AAS containing the 5G UE AAS with all submodels and including the following properties, which may be either static (unmodifiable) or dynamic (with a value modified by the UE or other AASs via the active part of the AAS).

1. Permanent equipment identifier (PEI)
2. Certificate status: valid/expired
3. Network access restrictions: geofence or list of CGIs (as defined by 3GPP TS 23.003)
4. 5G UE (radio part) data sheet: frequency bands, transmission power, antennas, L2/L3 capabilities, etc.
5. UE identity: GPSI
6. Subscription to location events
7. Connectivity QoS query
8. Connectivity QoS monitoring subscription
9. Localization report (in 5G UE AAS)

6 Beneficial AAS Use Cases

6.1 Use case 1: QoS orchestration in a 5G network

A 5G UE negotiates QoS requirements with the 5G network.

Adaptation of the QoS is triggered externally. For flexible manufacturing, the QoS requirements are handled by the UEs themselves [25].

Example: For manufacturing a batch of high-quality products, a 5G PLC must meet high-bandwidth QoS requirements for a 5G camera and 5G image analysis unit for automated inspection. The PLC is therefore a reserve unit that communicates the QoS requirements for a particular production batch. The inspection camera and image analysis unit are the applied data source and data sink, respectively.

Actors:

- Data source device that includes a 5G UE
- Data sink device that includes a 5G UE
- QoS reserve unit (5G UE or part of data source/sink or 5G core AF function)
- 5G network

Situation beforehand:

- 5G UEs are connected to the 5G network.
- The data source, data sink, and 5G network itself each have an active AAS.
- A trigger event initiates QoS adaptation for communication between the data source and the data sink.

Situation afterward:

- After successful negotiation, the QoS is adapted for communication between the 5G UE data source and the 5G UE data sink.

Main scenario:

- The AAS of the QoS reserve unit communicates its existing and new QoS requirements to the 5G network AAS.
- The 5G network AAS validates the QoS requirements.
- The reserve unit informs the data source and data sink.

6.2 Use case 2: firmware updates

A UE vendor supplies a firmware update and informs all UEs. For the updating process, each UE requires an additional short-term 5G network slice with dedicated requirements such as high bandwidth and advanced security mechanisms. The AAS of the UE negotiates its network slice requirement with the active AAS of the 5GC.

6.3 Use case 3: intrusion detection system (IDS)

An intrusion detection system (IDS) detects anomalous behavior by a 5G-connected machine. The machine must be

Fig. 22: Flexible cross-layer communication by multiple slices

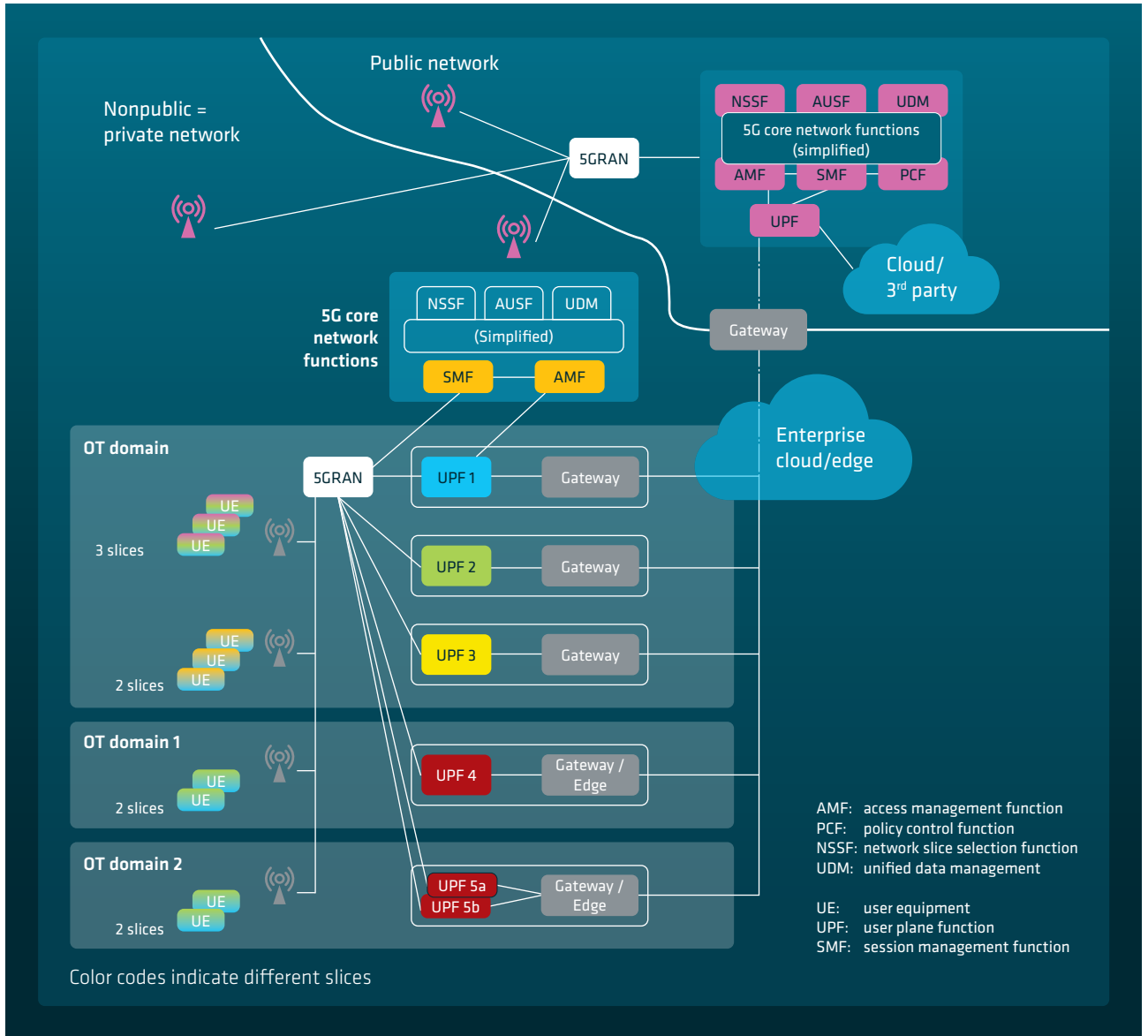

Source: 5G-ACIA

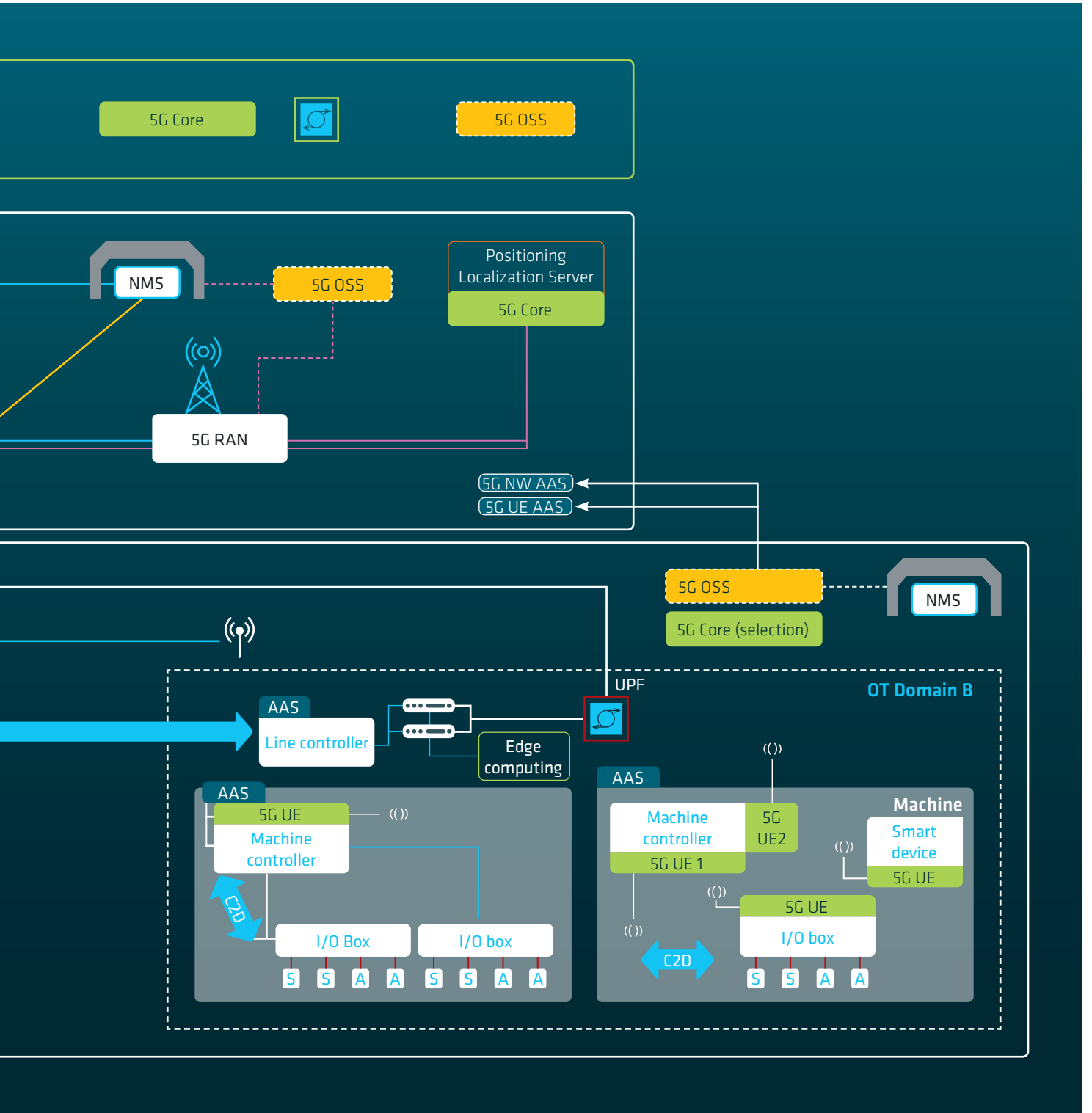

isolated and closely monitored in the network while continuing to ensure proper operation.

The active AAS of the IDS collects information on the network settings required for proper operation from the AAS of the 5G-connected machine. Then the IDS derives the requirements for an isolated (virtual) network for the 5G-connected machine and negotiates the requirements with the active AAS of the 5GC.

6.4 Use case 4: flexible communication across hierarchies enabled by 5G

5G can enable more flexible communication due to its embedded support for isolation, e.g. based on slicing. In addition, setup of communication endpoints can be flexibly defined depending on the requirements of each use case, the factory operator, and the communication relationships as discussed in above-mentioned 5G-ACIA white paper [3].

Each device equipped with 5G user equipment (UE) functionalities is able to request simultaneous connection to up to eight independent slices as defined in [1]. Each of the slices (connections) is isolated and linked to a data endpoint (user plane function or UPF and 5G core network functions) that can be defined depending on service and security requirements. A slice can support an arbitrary number of UPFs while the UE is served by at least one UPF.

Different slices, also within a factory, ensure secure isolated access to information across the hierarchies of the factory IT network.

6.5 Use case 5: service-specific deployment of UPFs

Each factory device runs multiple services at the same time as described in 3GPP TS22.104 and the 5G-ACIA white paper “A 5G Traffic Model for Industrial Use Cases” [4].

Some of the communication services connect a controller to multiple IO devices (e.g. sensors, actuators, or cameras) that are logically and physically situated within the OT domain. Most of the cyclic deterministic communication still takes place in this network segment, while data are exchanged between the device and SCADA system for status updates or with the MES for configuration updates. SCADA and MES are placed outside the protected OT domain and isolated by firewalls or gateways.

Independent instances of UPFs can be created for each communication motive. Figure 23 above illustrates multiple connections between the line controller and various communication endpoints. All type 1 connections with must pass via UPF1, while all type 2 connections are routed through UPF2. In addition, a PDU session can be concurrently served by multiple UPFs (e.g. for multihoming or redundancy purposes); the same UPF can support different PDU sessions for the same UE, while the UE can support up to 12 PDU sessions (Rel16) and different UEs can be served by different UPFs.

For example, a factory operator can set up PDU sessions that can have not just one but multiple endpoints (UPF) on the network side. For special needs such as redundancy, 5G supports the concurrent use of multiple UPFs.

For the most part, the 5G core network is shown as a monolithic building block comprising multiple functions (as described above): e.g. access and mobility functions (AMFs), session management functions (SMFs), and network exposure functions (NEFs). 5G actually provides greater flexibility for deploying core network functions across the factory depending on services' need for greater redundancy, resilience, fault tolerance, or scalability. The corresponding management service functions must be distributed accordingly.

All connections, configuration, and logical interfaces must be reported to the 5G network AAS to ensure a transparent and up-to-date overview of many thousands of connections and individual configurations. The 5G network AAS obtains this information from the 5G network management system and exposure functions enabled by the 5G core network.

7 Conclusions

This white paper provides an overview of how industrial 5G supports Industry 4.0 principles with highly flexible and secure communication links across a factory hall or entire manufacturing facility.

A prerequisite is integrating 5G into Industry 4.0 by defining 5G Asset Administration Shell (AAS). Different aspects are discussed and a model proposed for creating structured descriptions of an entire 5G network, including 5G UEs.

It is suggested that the dialog initiated with the expert groups of Plattform Industrie 4.0 be continued in order to work out the details of an AAS model for a 5G system. Several meetings with experts of the Models and Standards working group of ZVEI have identified topics in need of further clarification. Additional analysis is required of bootstrapping (i.e. onboarding), responses to dynamic changes to the 5G

infrastructure, and functions that are performed over the lifecycle. More valuable findings are expected as outputs of the work items on the OPC UA integration with 5G and elaboration of new service level agreements for 5G for Industry 4.0.

A new extension of the AAS, called “active AAS”, is also currently being discussed within the scope of the Industry 4.0 standardization activities. This active AAS would support and perform self-optimization of the overall factory network and processes, e.g. dynamic QoS negotiations. It would also include wireless connections and may require greater interaction of the factory and 5G networks. One of the goals in connection with Industry 4.0 is to unify the control and management of production systems, and a 5G system may become an integral part of this, being managed and controlled by factory network management systems.

8 Key Terms and Definitions

3GPP

The 3rd Generation Partnership Project (3GPP) is a collaborative project that brings together standardization organizations from around the world to create globally accepted specifications for mobile networks. As its name implies, it was first created to establish such specifications for the third generation (3G) of mobile communication systems. It has continued its work for subsequent generations, including the one considered here, the fifth generation (5G).

5G-ACIA

5G-ACIA is the world's leading organization for shaping and promoting industrial 5G.

5G system

A 5G system comprises a 5G core network (5GC), a next-generation radio access network (NG-RAN), and 5G user equipment (UE) in the form of mobile devices. The 5GC includes user plane functions (UPF) and control plane network functions such as the access and mobility management function

(AMF), session management function (SMF), and policy control function (PCF).

Access and Mobility Management Function (AMF)

The endpoint of CP protocols from the AN and UEs, this handles functions related to the mobility and access system of UEs.

Application Function (AF)

This function works between external networks and a 3GPP system to provide services to UEs. It possesses or can obtain information from external data networks or end user applications on services needed for UEs and interacts with 3GPP CN to provide them.

Asset Administration Shell (AAS)

Originally defined years ago by Plattform Industrie 4.0 as a basic information pool, the concept of AAS has evolved much further since then [15] [16]. Commands and information calls to I4.0 components can be initiated by a higher-level IT

system such as an MES or ERP as shown in Figure 9. A client in the superordinate IT system initiates an interaction with the server functionalities of the I4.0 systems. This interaction is referred to as vertical. The horizontal extension will now be standardized by Plattform Industrie 4.0 as an “active AAS”, also called “interactive AAS”. The concept of AAS is continuing to evolve in the “Networked AAS” project, the results of which will be integrated in a later version of this report.

Legacy Ethernet Bridge

A bridge that complies with IEEE Std 802.1Q-2015 or earlier. It is a basic Ethernet bridge without any TSN features such as Qbv, Qci, or Qbu.

Location Management Function (LMF)

The LMF initiates location procedures for ng-eNBs or gNBs in NG-RAN—for example, to obtain positioning measurements or assistance data.

Network Data Analytics Function (NWDAF)

NWDAF, which is defined in 3GPP TS 29.520, incorporates standard interfaces from a service-based architecture to collect data by subscription or request from other network functions and similar procedures. This is for making analysis functions available in the network for automation or reporting and resolving major custom interface or format challenges.

Network Exposure Function (NEF)

This function can interact with external networks and expose the functionality of the 5G system to them.

Network Repository Function (NRF)

Keeps track of NFs and their services and makes this information available for discovering the required services.

Network-Side TSN Translator (NW-TT)

The 5GS was modeled as a “virtual” or “logical” TSN bridge providing control plane connectivity and TSN ports on the user plane (see Figure 15). This model includes a TSN translator (TT) functionality that is available (i) on the control plane using a TSN application function (AF), (ii) on the UE side using a device-side TT (DS-TT), and (iii) on the UPF side using a network-side TT (NW-TT).

Network Slice Selection Function (NSSF)

Supports selection of the appropriate network slice for each UE.

Policy Control Function (PCF)

Interconnects with other control functions to enforce system policies. To be able to do this, it holds information on policies in the system and can access UE subscription information.

Protocol Data Unit (PDU) Session

Communication association in a 5G network for communication between a UE and a data network.

Service Communication Proxy (SCP)

This element supports interactions between FEs when no direct connection is used, e. g. by acting as a proxy for service discovery and communication.

Session Management Function (SMF)

Controls a UE’s data sessions and (for example) allocates a UPF to it.

TSN Translator (TT)

A 5G system function, defined in 3GPP and located at the “edge” of the 5G network, which interacts with external TSN nodes on both the control plane and user plane. On the control plane, a TT is a 5G core network application function (TSN AF) used to interact with TSN control and management, e. g. CNC. On the user plane, there are device-side TTs (DS-TTs) and network-side TTs (NW-TT) on the UE and UPF sides, respectively.

Unified Data Management (UDM)

Provides access to repositories containing user-related service data, e. g. for the purpose of identifying and authenticating a user for service.

User Equipment (UE)

Mobile devices that the end user or application uses at the device end to communicate via the 5G network.

User Plane Function (UPF)

Serves as a UP gateway between 5G and external data networks. Anchors a UE's data sessions from the external data network's perspective (hiding mobility). Multiple UPFs can be deployed.

Industrial Communication Network, also called the Industrial Ethernet Network

Fieldbus profiles for real-time networks based on ISO/IEC/IEEE 8802-3. Examples include CC-Link, EtherCAT, Ethernet/IP, POWERLINK, PROFINET, and Sercos III.

9 Acronyms

5G-ACIA	5G Alliance for Connected industries and Automation	PDU	Protocol data unit
3GPP	3rd Generation Partnership Project	PLC	Programmable logic controller
5G	5th Generation cellular network	QoS	Quality of Service
5GC	5G core network	RAN	Radio access network
5GS	5G System	SMF	Session management function
5QI	5G QoS indicator	TR	Technical report
AAS	Asset Administration Shell	TSN	Time-sensitive networking
AF	Application function	TSN AF	TSN application function
AMF	Access and mobility management function	UE	User equipment
CNC	Central network configuration	UPF	User plane function
DN	Data network (3GPP term)	VLAN	Virtual LAN
DS-TT	Device-side TSN translator		
ERP	Enterprise resource planning		
gNB	g-node B (5G NR base station)		
IIoT	Industrial Internet of Things		
IP	Internet protocol		
L2	Layer 2 communication based on IEEE 802.3		
L2T	Layer 2 tunneling		
L3	Layer 3 communication, routed IP-based communication		
LAN	Local area network		
LMF	Location management function		
MES	Manufacturing execution system		
NG-RAN	Next generation – radio access network		
NMS	Network management system		
NPN	Non-public network		
NWDAF	Network data analytics function		
NW-TT	Network-side TSN translator		
OPC	Open platform communication		

10 References

- [1] 3GPP TS 23.501: *System Architecture for the 5G System; Stage 2*
- [2] 3GPP TS 38.401: *NG-RAN, Architecture description; Rel16*
- [3] 5G-ACIA white paper: *5G Non-Public Networks for Industrial Scenarios*, www.5g-acia.org
- [4] 5G-ACIA white paper: *Integration of Industrial Ethernet Networks with 5G Networks*, November 2019
- [5] 5G-ACIA white paper: *A 5G Traffic Model for Industrial Use Cases*, November 2019
- [6] 5G-ACIA white paper: *Predictive Data Analytics for Industrial Automation*, September 2020
- [7] 5G-ACIA white paper: *Exposure of 5G capabilities for connected industries and automation applications*, July 2020
- [8] 5G-ACIA white paper: *Security Aspects of 5G for Connected industries and Automation*, July 2020
- [9] "ZVEI Fachverband Automation, white paper: *Kommunikation im Industry-4.0-Umfeld, Part 4*, April 2018 (in German)
- [10] Wollschlaeger, Martin; Thilo Sauter; and Juergen Jasperneite: *The future of industrial communication: Automation networks in the era of the internet of things and Industry 4.0.*, IEEE Industrial Electronics Magazine 11.1 (2017): 17-27 https://www.hs-owl.de/init/uploads/tx_initdb/IEEEMagazine.pdf
- [11] IEC 61158 series, *Industrial Communication Networks – Fieldbus Specifications*
- [12] IEC 61784-2: *Industrial Communication Networks – Profiles – Part 2: Additional fieldbus profiles for real-time networks based on ISO/IEC/IEEE 8802-3*
- [13] IEC/IEEE 60802: *TSN Profile for Industrial Automation*, <https://1.ieee802.org/tsn/iec-ieee-60802/>
- [14] TSN: *IEEE 802.1 set of standards using synchronized services and time aware shaping, cyclic scheduling, pre-emption, ingress filtering or redundancy*
- [15] Federal Ministry for Economic Affairs and Energy (BMWi): *Details of the Asset Administration Shell – Part 1, Version 2.0.1, Platform I4.0, May 2020*
- [16] ZVEI, white paper: *Examples of the Asset Administration Shell for Industry 4.0 Components – Basic Part*, April 2017
- [17] *The Structure of the Administration Shell: TRILATERAL PERSPECTIVES from France, Italy and Germany*, March 2018
- [18] Grotepass, J.; Eichinger, J.; Voigtländer, F.: *Mit 5G zu neuen Potentialen in Produktion und Logistik, Handbuch Industry 4.0*, Springer Vieweg, (2019) (in German)
- [19] *White paper: Automation ML*, [https://www.automationml.org/o.red/uploads/dateien/1417686950-AutomationML Whitepaper Part 1 - AutomationML Architecture v2_Oct2014.pdf](https://www.automationml.org/o.red/uploads/dateien/1417686950-AutomationML%20Whitepaper%20Part%201%20-%20AutomationML%20Architecture%20v2_Oct2014.pdf)
- [20] Christian Diedrich et al.: *Sprache für I4.0-Komponenten – Semantik der Interaktionen von I4.0-Komponenten*, 2018 (in German)
- [21] *The background to Plattform Industrie 4.0*, <https://www.plattform-i40.de/PI40/Navigation/EN/ThePlatform/Background/background.html>, July 2020
- [22] *NAMUR Open Architecture*, presentation at www.namur.net/de/fokusthemen/namur-open-architecture.html, July 2020
- [23] Roland Heidel, Michael Hoffmeister, Martin Hankel, Udo Döbrich: *Industry 4.0, Reference Architecture Model RAMI 4.0 and the Industry 4.0 component*, Beuth-Edition
- [24] F. Prinz et al., *End-to-end Redundancy between Real-time I4.0 Components based on Time-Sensitive Networking*, 2018 IEEE 23rd International Conference on Emerging Technologies and Factory Automation, 2018, pp. 1083-1086
- [25] Thomas Kobzan, Alexander Boschmann, Simon Althoff, Immanuel Blöcher, conference paper: *Plug&Produce durch Software-defined Networking*, November 2018 (in German)
- [26] IEC TC65C – Industrial Networks, 65C/1027/CC: *Compilation of Comments on 65C/1005/CD – IEC 62657-3 ED1: Industrial communication networks – Wireless communication networks*

- [27] OPC-UA, <https://opcfoundation.org/about/opc-technologies/opc-ua/>, The OPC Unified Architecture (UA), released in 2008, is a platform independent service-oriented architecture that integrates all the functionality of the individual OPC Classic specifications into one extensible framework
- [28] “Network-based Communication for Industrie 4.0 – Proposal for an Administration shell”, Plattform Industrie 4.0, AG1, Sub-working group Network-based-communication, November 2016

5G-ACIA White Paper

Using Digital Twins
to Integrate 5G into Production Networks

Contact

5G Alliance for Connected Industries and
Automation (5G-ACIA), a Working Party of ZVEI
Lyoner Strasse 9
60528 Frankfurt am Main
Germany
Phone: +49 69 6302-209
Fax: +49 69 6302-319
Email: info@5g-acia.org
www.5g-acia.org

Published by

ZVEI - German Electrical and
Electronic Manufacturers' Association
5G Alliance for Connected Industries and
Automation (5G-ACIA), a Working Party of ZVEI
www.zvei.org

February 2021

Design: COBRAND Berlin

© ZVEI

The work, including all of its parts, is protected by copyright. Any use outside the strict limits of copyright law without the consent of the publisher is prohibited. This applies in particular to reproduction, translation, microfilming, storage, and processing in electronic systems. Although ZVEI has taken the greatest possible care in preparing this document, it accepts no liability for the content.

11 5G-ACIA Members

As of February 2021





www.5g-acia.org